

**RIGOL**

# Test & Measurement Product Catalog



**alldata**  
EASTERN EUROPE

# Contents

## Digital Oscilloscopes 3

---

DS8000-R Series Digital Oscilloscopes	4
MSO8000 Series Digital Oscilloscopes	7
MSO/DS7000 Series Digital Oscilloscopes	10
MSO5000 Series Digital Oscilloscopes	13
MSO/DS2000A Series Digital Oscilloscopes	16
DS1000Z-E Series Digital Oscilloscopes	18
DS1000Z Series Digital Oscilloscopes	20
DS1000E Series Digital Oscilloscopes	22
Bus Analysis Guide	23
Power Measurement and Analysis	24
Probes	26

## Spectrum Analyzers 28

---

RSA5000 Series Spectrum Analyzers	29
RSA3000 Series Spectrum Analyzer	32
RSA3000E Series Spectrum Analyzer	35
DSA800/E Series Spectrum Analyzers	37
DSA700 Series Spectrum Analyzers	39
EMI Test System(S1210)	41
NFP-3 Near Field Probes	41
Common RF Accessories	42
RF Accessories Selection Guide	43

## RF Signal Generators 44

---

DSG3000B Series RF Signal Generators	45
DSG800 Series RF Signal Generators	47

## Function/Arbitrary Waveform Generators 49

---

DG5000 Series Function/Arbitrary Waveform Generators	50
DG4000 Series Function/Arbitrary Waveform Generators	52
DG2000 Series Function/Arbitrary Waveform Generators	54
DG1000Z Series Function/Arbitrary Waveform Generators	56
DG900 Series Function/Arbitrary Waveform Generators	58
DG800 Series Function/Arbitrary Waveform Generators	60

## Digital Multimeters 62

---

DM3058 5½ Digits Digital Multimeters	62
DM3058E 5½ Digits Digital Multimeters	62
DM3068 6½ Digits Digital Multimeters	62

## Data Acquisition/Switch Systems 64

---

M300 Series Data Acquisition/Switch Systems	64
---	----

## Programmable DC Power Supplies 66

---

DP800 Series Programmable DC Power Supplies	67
DP700 Series Programmable DC Power Supplies	69

## Programmable DC Electronic Loads 71

---

DL3000 Series Programmable DC Electronic Loads	71
--	----

# Digital Oscilloscopes



Digital oscilloscope, an essential electronic equipment for R&D, manufacture and maintenance, is used by electronic engineers to observe various kinds of analog and digital signals. RIGOL is a leading manufacturer and supplier of digital oscilloscope in China and has made many breakthroughs in the domestic industry. It introduces 6 generations of oscilloscopes since its creation. MSO8000 series digital oscilloscope use the special ASIC chip for digital oscilloscope developed by RIGOL. The consistency and reliability of digital oscilloscope has been greatly improved. The whole memory hardware is used to measure it with high accuracy, which also supports

histogram analysis and waveform search, providing a more efficient way to solve the problem of waveform location and analysis. The innovative technique "UltraVision" and "UltraVision II" makes RIGOL oscilloscopes realize deeper memory depth, higher waveform capture rate, hardware full memory auto measurement, real time waveform record and multi-level intensity grading display. Now RIGOL has developed several series of oscilloscopes (including DS1000Z, DS1000Z-E, MSO/DS2000A, MSO5000, MSO/DS7000, MSO8000, and DS8000-R) to meet different customer needs and to improve the testing efficiency.

Series	Analog Channels	Digital Channels (MSO)	Max. Sample Rate	Max. Memory Depth	AWG	Bus Analysis	Bandwidth Range(MHz)													
							2000	1000	600	500	350	300	200	150	100	70	50			
DS8000-R	4	--	10 GSa/s	500 Mpts	•	•	•	•			•									
MSO8000	4	16	10 GSa/s	500 Mpts	•	•	•	•	•											
MSO/DS7000	4	16	10 GSa/s	500 Mpts	• <sup>①</sup>	•			•	•		•		•						
MSO5000	2 / 4	16	8 Gsa/s	200 Mpts	•	•				•		•	•	•	•					
MSO/DS2000A	2	16	2 Gsa/s	56 Mpts	•	•					•	•		•						
DS1000Z-E	2	--	1 Gsa/s	24 Mpts		•						•		•						
DS1000Z	2 / 4	16 <sup>②</sup>	1 Gsa/s	24 Mpts	•	•						•		•		•	•	•		
DS1000E	2	--	1 Gsa/s	1 Mpts										•						•

• Standard or Option, could be supported.

① Option available for MSO models

② Only Plus Models support

# DS8000-R Series Digital Oscilloscope



DS8000-R series is a medium and high-end mixed signal digital oscilloscope with a compact size designed on the basis of the ASIC chip (RIGOL self-owns its intellectual property right) and UltraVision II technical platform developed by RIGOL. It is compact and thin in design. It supports system integration of multiple devices, rack mount installation, and remote system operation to meet the system requirements for industrial automation test system. DS8000-R series oscilloscope has an analog bandwidth of up to 2 GHz, supporting multi-device synchronous triggering, available to be extended to 512 channels. It provides an excellent solution for users to meet their high-speed requirement for the system integration test and synchronization requirement for multi-channel data acquisition.

- Analog channel bandwidth: 350 MHz, 1 GHz, and 2 GHz
- Up to 10 GSa/s real-time sample rate (for DS8104-R/DS8204-R), 5 GSa/s (for DS8034-R)
- 4 analog channels, 1 EXT input channel
- Standard memory depth up to 500 Mpts
- High waveform capture rate (over 600,000 wfm/s)
- Low jitter, multiple-device synchronization (<200 psRMS, typical)
- High-speed data communication interface (10 GE SFP+), ensuring the reliable transmission of large data
- Integrates 6 independent instruments into 1, including digital oscilloscope, spectrum analyzer, AWG (option), digital voltmeter, 6-digit counter and totalizer, and protocol analyzer (option)
- Available to be extended to 512 channels, supporting synchronous acquisition
- Real-time eye diagram and jitter analysis software (option)
- Built-in advanced power analysis software (option)
- Operating temperature low below -40°C, available to be used for signal monitoring in some special conditions
- Multiple interfaces available: USB HOST&DEVICE, LAN(LXI), 10 GE SFP+, HDMI, TRIG OUT, 10 MHz In, and 10 MHz Out
- Web Control remote command
- Compact and thin design, save rack space, 1U rack mount kit (standard)
- Software development kit available for users to meet their customized development according to their specific scenarios
- Easy-to-use on-site multi-channel synchronization calibration kit, enabling you to view multiple channels synchronously

## Compact Design



Thin and compact in body design: 214 mm (W)×43 mm (H)×478 mm (D)

## Convenient Stand-alone Working Mode



A single device with peripherals can meet traditional oscilloscope applications: connect the display device through the HDMI interface to view the user interface, connect the mouse through the USB Host interface to click and drag, and connect the keyboard to set numbers or strings.

## Suitable for low temperature working environment



Without a LCD screen, the minimum working temperature for DS8000R is -40°C, and it can be applied to signal monitoring in special environments.

## Save the rack space



1U rack allows two sets of oscilloscopes (with a total of 8 channels) to be installed in parallel, greatly saving the rack space.

## Synchronous Triggering Capability with Extended 512 Channels

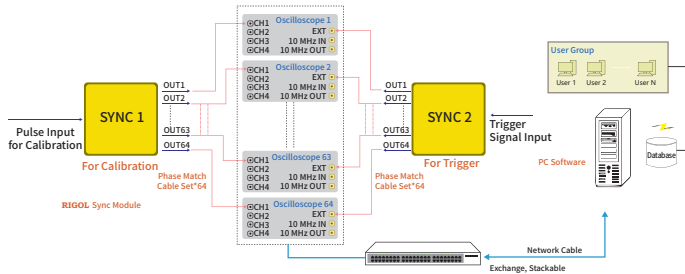

The synchronization module provides multi-device synchronization schemes and on-site multi-channel synchronization calibration kit, enabling you to view multiple channels synchronously

## Multi-channel high-speed data acquisition



The multi-channel high-speed data acquisition software (option) can be used to configure multiple devices and channels, provide user-friendly interface to display the acquired waveforms of each channel.

## Models and Specifications

Model	DS8104-R	DS8204-R	DS8034-R
Analog BW (50 Ω, -3 dB) <sup>[1]</sup>	1 GHz	2 GHz	350 MHz
Analog BW (1 MΩ, -3 dB)	500 MHz		350 MHz
Calculated Rising Time under 50 Ω (single-channel mode, 10%-90%, typical)	≤350 ps	≤225 ps	≤1ns
No. of Input/Output Channels	4 Input Analog Channels		
	1 Input EXT Channel		
Sampling Mode	Arbitrary waveform generator output (required to purchase the DS8000-R-AWG option)		
	Real-time Sampling		
Max. Sample Rate of Analog Channel	10 GSa/s (single-channel), 5 GSa/s (half-channel <sup>[2]</sup> ), 2.5 GSa/s (all channels)		5 GSa/s (single-channel), 5 GSa/s (half-channel), 2.5 GSa/s (all channels)
	Note: When all the channels are enabled, the sample rate is 2.5 GSa/s, and the analog bandwidth can reach up to 1 GHz.		
Max. Memory Depth	500 Mpts (single-channel), 250 Mpts (half-channel <sup>[2]</sup> ), 125 Mpts (all channels)		
Max. Waveform Capture Rate <sup>[3]</sup>	≥600,000 wfms/s		
Hardware Real-Time Waveform Recording and Playing	≥450,000 wfms (single-channel)		
Peak Detection	capture 400 ps glitches		capture 800 ps glitches
Range of Time Base	1 GHz	2 GHz	
	200 ns/div~1 ks/div	200 ns/div~1 ks/div	
Vertical Sensitivity Range <sup>[4]</sup>	Fine	1 mV/div~10 V/div	
	1 MΩ	1 mV/div~1 V/div	
DC Gain Accuracy <sup>[4]</sup> ± 2% of full scale	± 2% of full scale		
Decoding Type	Standard: Parallel Option: RS232/UART, I2C, SPI, LIN, CAN, FlexRay, I2S, and MIL-STD-1553		
Trigger Type	Option: RS232/UART, I2C, SPI, LIN, CAN, FlexRay, I2S, and MIL-STD-1553 Option: RS232/UART, I2C, SPI, CAN, FlexRay, LIN, I2S, and MIL-STD-1553		
Waveform Calculation	A+B, A-B, AxB, A/B, FFT, A&&B, A  B, A^B, !A, Intg, Diff, Sqrt, Lg, Ln, Exp, Abs, AX+B, LowPass, HighPass, BandPass, and BandStop		
Waveform Measurement	Qty.	41 auto measurements; and up to 10 measurements can be displayed at a time.	
	Analysis	Frequency counter, DVM, power analysis (option), histogram, zone trigger, eye diagram (option), and jitter analysis (option)	
Enhanced FFT	Record Length	Max. 1 Mpts	
	Window Type	Rectangular, Blackman-Harris, Hanning (default), Hamming, Flattop, and Triangle.	
	Peak Search	A maximum of 15 peaks, confirmed by the settable threshold and offset threshold set by users	
Arbitrary Waveform Generator	25 MHz, single-channel (required to purchase the AWG option)		
Interface	USB2.0 Host, USB2.0 Device, LAN, GPIB (option), WEB, AUX Out, 10 M In/Out, HDMI, Probe Compensation Output, SFP+ interface		
Size	without handles and hanging ears: 214 mm (W)×43 mm (H)×478 mm (D) with handles and hanging ears: 268 mm (W)×43 mm (H)×499 mm (D)		
Weight <sup>[5]</sup>	Package Excluded <3.6 kg Package Included <7.1 kg		

Note[1]: 2 GHz bandwidth is only applicable to single-channel or half-channel mode.

Note[2]: Half-channel mode: CH1 and CH2 are considered as a group; CH3 and CH4 are considered as another group. Each group share the sample rate of 5 GSa/s, and either one of the channels in each group is enabled.

Note[3]: Maximum value. DS8104-R/DS8204-R: single-channel, memory depth Auto, 10 ns horizontal time base, input amplitude 4 div, sine wave signal with 10 MHz frequency. Others are default settings. For DS8034-R: single-channel, memory depth Auto, 20 ns/div horizontal time base, input amplitude 4 div, sine wave signal with 10 MHz frequency. Others are default settings.

Note[4]: 1 mV/div and 2 mV/div are a magnification of 4 mV/div setting. For vertical accuracy calculations, use full scale of 32 mV for 1 mV/div and 2 mV/div sensitivity setting.

Note[5]: DS8000-R model, standard configuration.

## Order Information

Order Information	Order No.
<b>Model</b>	
DS8204-R (2 GHz, 10 GSa/s, 500 Mpts, 4CH compact digital oscilloscope)	DS8204-R
DS8104-R (1 GHz, 10 GSa/s, 500 Mpts, 4CH compact digital oscilloscope)	DS8104-R
DS8034-R (350 MHz, 5 GSa/s, 500 Mpts, 4CH compact digital oscilloscope)	DS8034-R
<b>Standard Accessories</b>	
USB cable	CB-USBA-USBB-FF-150
Power cord conforming to the standard of the destination country	—
Rack mount kit	RM1011 & RM1012
<b>Recommended Accessories</b>	
Passive high-impedance probe (500 MHz BW)	RP3500A
Passive high-impedance probe (350 MHz BW)	PVP2350
Passive low-impedance probe (1.5 GHz BW)	RP6150A
Active differential probe (2.5 GHz BW)	PVA7250
Active differential probe (1.5 GHz BW)	RP7150
Active differential probe (800 MHz BW)	RP7080
Active single-ended probe (1.5 GHz BW)	RP7150S
Active single-ended probe (800 MHz BW)	RP7080S
Power analysis phase difference correction jig	RPA246
64CH synchronization module	DS SYNC64
2-way power splitter (DC to 4 GHz)	PRSC42
<b>10 GE Communication Option</b>	
High-speed data communication option	DS8000-R-HSDC
<b>Software Tool</b>	
Software development kit (open source, available to download from RIGOL official website)	—
<b>Bundle Option</b>	
Function and application bundle option, including DS8000-R-COMP, DS8000-R-EMBD, DS8000-R-AUTO, DS8000-R-FLEX, DS8000-R-AUDIO, DS8000-R-AERO, DS8000-R-AWG, DS8000-R-JITTER and DS8000-R-PWR	DS8000-R-BND
<b>Serial Protocol Analysis Option</b>	
PC serial bus trigger and analysis (RS232/UART)	DS8000-R-COMP
Embedded serial bus trigger and analysis (I2C, SPI)	DS8000-R-EMBD
Auto serial bus trigger and analysis (CAN, LIN)	DS8000-R-AUTO
FlexRay serial bus trigger and analysis (FlexRay)	DS8000-R-FLEX
Audio serial bus trigger and analysis (I2S)	DS8000-R-AUDIO
MIL-STD-1553 serial bus trigger and analysis (MIL-STD-1553)	DS8000-R-AERO
<b>Measurement Application Option</b>	
25 MHz arbitrary waveform generator	DS8000-R-AWG
Built-in power analysis (required to purchase the RPA246 phase deviation correction jig)	DS8000-R-PWR
Real-time eye diagram and jitter analysis (option)	DS8000-R-JITTER

Note: For all the mainframes, accessories and options, please contact the local office of RIGOL.

# MSO8000 Series Digital Oscilloscopes



The MSO8000 Series Oscilloscopes combine best in class sampling and memory depth with our modern, flexible User Interface enabled by our new UltraVision II architecture and innovative Phoenix Chipset. With 600 MHz, 1 GHz, and 2 GHz models each with 4 analog channels the MSO8000 Series brings RIGOL's UltraVision II performance to the high speed engineering bench. The MSO8000 also adds Jitter and Real-time Eye Analysis capabilities in addition to other UltraVision II functions including zone triggering, 7 instruments in one, Enhanced FFTs, color grading, and histograms all supported by the high sample rate, deep memory, and full memory measurements.

- Analog bandwidth: 600 MHz, 1 GHz, and 2 GHz (single-channel and half-channel modes); bandwidth upgrade supported
- 4 analog channels, 1 EXT channel, and 16 standard configuration of digital channels (required to purchase the probe)

- Up to 10 GSa/s real-time sample rate
- Up to 500 Mpts memory depth (standard)
- High waveform capture rate (over 600,000 waveforms per second)
- Up to 450,000 frames of hardware real-time and ceaseless waveforms recording and playback functions
- Integrates 7 independent instruments into 1, including digital oscilloscope, 16-channel logic analyzer, spectrum analyzer, arbitrary waveform generator (option), digital voltmeter, 6-digit frequency counter and totalizer, and protocol analyzer (option)
- Auto measurement of 41 waveform parameters; full-memory hardware measurement function
- Real-time eye diagram and jitter analysis software (option)
- 10.1-inch capacitive multi-touch screen, 256-level intensity grading display, with color persistence

## 2GHz bandwidth, 10GSa/s sampling rate

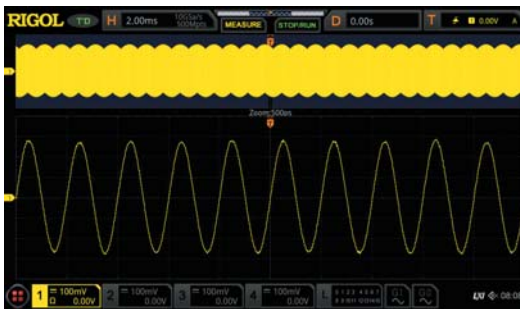

To achieve higher signal fidelity and resolution (as short as 100 ps, capable of reaching 2 ps for the minimum time base) at an affordable price.

## Visualize Signal Integrity with Advanced Jitter Measurement



Perform TIE measurement on the clock signal with the jitter and make an analysis on the measurement results through trend graph and histogram.

## Eye Diagram Pre-test Easy



To better observe the transmission quality of the digital signal and understand the Inter-Symbol Interference in the system, so that you can make improvement in the system design.

## 600,000 wfms/s Capture Rate



Capture occasional exceptional signals in a highly refreshed mode.

## Hardware Full Memory Auto Measurement

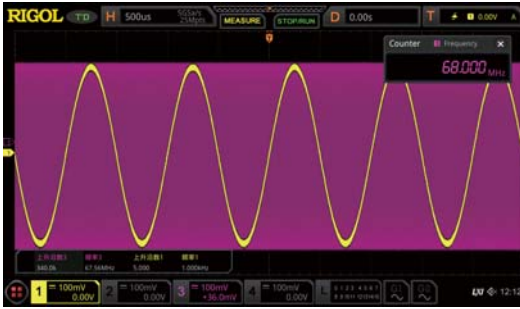

Measure accurate frequency value of the waveforms based on memory, not the screen display.

500 Mpts memory depth, 450,000 frames waveforms recording and playback.



Based on segmented storage technology, deep memory not only ensured the high capture efficiency, but also prolonged the overall observation time for the waveforms.

## Key Specifications

Model	MSO8064	MSO8104	MSO8204
Analog Bandwidth	600 MHz	1 GHz	2 GHz <sup>[1]</sup>
No. of Input/Output Channels	4 input analog channels 1 input EXT channel 16 input digital channels (required to purchase the RPL2316 logic analyzer probe) dual-channel arbitrary waveform generator output (required to purchase the MSO8000-AWG option)		
Max. Sample Rate of Analog Channel	10 GSa/s (single-channel), 5 GSa/s (half-channel <sup>[2]</sup> ), 2.5 GSa/s (all channels) Note: When all the channels are enabled, the sample rate is 2.5 GSa/s, and the analog bandwidth can reach up to 1 GHz.		
Max. Memory Depth	analog channel: 500 Mpts (single-channel), 250 Mpts (half-channel <sup>[2]</sup> ), 125 Mpts (all channels) digital channel: 62.5 Mpts (all channels)		
Max. Waveform Capture Rate	≥600,000 wfms/s		
Range of Time Base	600 MHz 500 ps/div~1 ks/div support fine adjustment	1 GHz 500 ps/div~1 ks/div	2 GHz 200 ps/div~1 ks/div
Vertical Sensitivity	1 MΩ	1 mV/div~10 V/div	
Range	50 Ω	1 mV/div~1 V/div	
DC Gain Accuracy	± 2% of full scale		
Hardware Real-time Waveform Recording and Playing	≥450,000 wfms (single-channel)		
Trigger Type	Standard: Edge trigger, Pulse trigger, Slope trigger, Video trigger, Pattern trigger, Duration trigger, Timeout trigger, Runt trigger, Window trigger, Delay trigger, Setup/Hold trigger, and Nth Edge trigger Option: RS232, UART, I2C, SPI, CAN, FlexRay, LIN, I2S, and MIL-STD-1553		
Decoding Type	Standard: Parallel Option: RS232, UART, I2C, SPI, LIN, CAN, FlexRay, I2S, and MIL-STD-1553		
Waveform Measurement	Number of Measurements	41 auto measurements; and up to 10 measurements can be displayed at a time.	
	Analysis	Frequency counter, DVM, power analysis (option), histogram, zone trigger, eye analysis (option), and jitter analysis (option)	
Waveform Calculation	A+B, A-B, AxB, A/B, FFT, A&B, A  B, A^B, !A, Intg, Diff, Lg, Ln, Exp, Sqrt, Abs, AX+B, LowPass, HighPass, BandPass, BandStop, and Trend		
Enhanced FFT	Record Length	Max. 1 Mpts	
	Window Type	Rectangular (default), Blackman-Harris, Hanning, Hamming, Flattop, and Triangle.	
	Peak Search	a maximum of 15 peaks, confirmed by the settable threshold and offset threshold set by users	
Arbitrary Waveform Generator	25 MHz, 2 CH (Need AWG option)		
Interface	USB2.0 Host, USB2.0 Device, LAN, GPIB(option), WEB, AUX output, 10M In/Out, HDMI, Probe Compensation Output		
LCD Size and Type	10.1-inch capacitive multi-touch screen/gesture enabled operation		
Display Resolution	1024 × 600		
Dimensions	410 mm (W)×224 mm (H)×135 mm (D)		
Weight	<4.0 kg (Package Excluded)		

Note<sup>[1]</sup>: 2 GHz bandwidth is only applicable to single-channel or half-channel mode.

Note<sup>[2]</sup>: Half-channel mode: CH1 and CH2 are considered as a group; CH3 and CH4 are considered as another group. Each group share the same sample rate 5 GSa/s, and either one of the channels in each group is enabled.



## Ordering Information

Order Information	Order No.
<b>Models</b>	
MSO8204 (2 GHz, 10 GSa/s, 500 Mpts, 4+16 CH MSO)	MSO8204
MSO8104 (1 GHz, 10 GSa/s, 500 Mpts, 4+16 CH MSO)	MSO8104
MSO8064 (600 MHz, 10 GSa/s, 500 Mpts, 4+16 CH MSO)	MSO8064
<b>Standard Accessories</b>	
USB cable	CB-USBA-USBB-FF-150
4 passive high-impedance probes (500 MHz)	RP3500A
2 passive low-impedance probes (1.5 GHz, only for MSO8204/MSO8104)	RP6150A
Front panel cover	MSO8000-FPC
Power cord conforming to the standard of the destination country	-
<b>Recommended Accessories</b>	
16-channel logic analyzer probe	RPL2316
Active differential probe (1.5 GHz BW)	RP7150
Active differential probe (800 MHz BW)	RP7080
Active single-ended probe (1.5 GHz BW)	RP7150S
Active single-ended probe (800 MHz BW)	RP7080S
Active differential probe (2.5 GHz BW)	PVA7250
Rack mount kit	RM6041
USB-GPIB interface converter	USB-GPIB
Near-field probe	NFP-3
Power analysis phase deviation correction jig	RPA246
<b>Bandwidth Upgrade Option</b>	
Bandwidth upgrades from 600 MHz to 1 GHz	MSO8000-BW6T10
Bandwidth upgrades from 600 MHz to 2 GHz	MSO8000-BW6T20
Bandwidth upgrades from 1 GHz to 2 GHz	MSO8000-BW10T20
<b>Bundle Option</b>	
Function and application bundle option, including MSO8000-COMP, MSO8000-EMBD, MSO8000-AUTO, MSO8000-FLEX, MSO8000-AUDIO, MSO8000-AERO, MSO8000-AWG, MSO8000-JITTER and MSO8000-PWR	MSO8000-BND
<b>Serial Protocol Analysis Option</b>	
PC serial bus trigger and analysis (RS232/UART)	MSO8000-COMP
Embedded serial bus trigger and analysis (I2C, SPI)	MSO8000-EMBD
Auto serial bus trigger and analysis (CAN, LIN)	MSO8000-AUTO
FlexRay serial bus trigger and analysis (FlexRay)	MSO8000-FLEX
Audio serial bus trigger and analysis (I2S)	MSO8000-AUDIO
MIL-STD-1553 serial bus trigger and analysis (MIL-STD-1553)	MSO8000-AERO
<b>Measurement Application Option</b>	
Dual-channel 25 MHz arbitrary waveform generator	MSO8000-AWG
Built-in power analysis (required to purchase the RPA246 phase deviation correction jig)	MSO8000-PWR
Real-time eye diagram and jitter analysis	MSO8000-JITTER

# MSO/DS7000 Series Digital Oscilloscopes



MSO/DS7000 Series Digital Oscilloscope adopts RIGOL's self-developed ASIC chip for digital oscilloscope, which can gain the data acquisition capability of up to 10 GSa/s real-time sample rate, realizing the high integration of all the function modules required for the analog front-end(AFE), and greatly improving the consistency and reliability of the digital oscilloscope.

- Analog bandwidth: 500 MHz, 350 MHz, 200 MHz, and 100 MHz; bandwidth upgrade option supported
- 4 analog channels, 1 EXT channel, 16 digital channels (option)
- Up to 10 GSa/s real-time sample rate
- Up to 500 Mpts memory depth (option)

- High waveform capture rate (over 600,000 waveforms per second)
- Up to 450,000 frames of hardware real-time and ceaseless waveforms recording and playback Functions
- Integrates 7 independent instruments into 1, including one digital oscilloscope, one 16-channel logic analyzer, one spectrum analyzer, one arbitrary waveform generator, one digital voltmeter, one high-precision frequency counter and totalizer, and one protocol analyzer
- A variety of serial protocol triggers and decodes
- 10.1-inch capacitive multi-touch screen, 256-level intensity grading display, with color persistence

## 7-into-1 Integrated Digital Oscilloscope

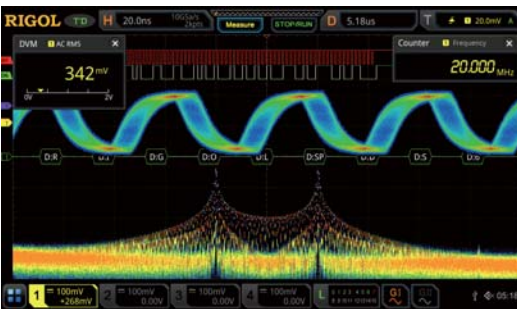

Include one digital oscilloscope, one 16-channel logic analyzer, one spectrum analyzer, one arbitrary waveform generator, one digital voltmeter, one high-precision frequency counter and totalizer, and one protocol analyzer

## Hardware Full Memory Auto Measurement



Observe and accurately measure two signals with great frequency deviations

## Over 600,000 wfms/s Capture Rate



Capture occasional exceptional signals in a highly refresh mode

## Hardware Waveform Recording and Playback

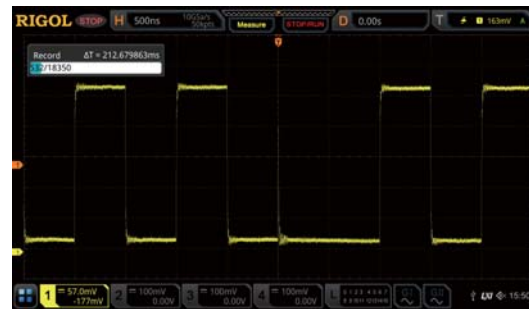

Adopt the segmented storage technology, you can set the trigger conditions to make a selective choice in capturing and saving the signals that you are interested in

## Variety of Protocol Decodings



Support 4 serial buses simultaneously. The full memory data analysis and the decoding event table display can help engineers quickly find out the system failure and locate the symbol error waveforms

## Histogram Analysis



Measurement histogram is applicable for observing the distribution of the measurement signal over a long period of time to help users quickly find out the potential abnormalities of the signal.

## Key Specifications

Model	MSO7014	DS7014	MSO7024	DS7024	MSO7034	DS7034	MSO7054	DS7054
Analog BW	100MHz		200 MHz		350 MHz		500 MHz	
Analog Channels	4 analog channels							
Digital Channels	16 digital channels (only for the MSO model)							
Max. Sample Rate of Analog Channel	10 GSa/s(single-channel),5 GSa/s(dual-channel),2.5 GSa/s(four-channel)							
Max. Memory Depth	Analog Channel, 500 Mpts(single-channel), 250 Mpts(dual-channel),125 Mpts(four-channel) Digital Channel: 62.5 Mpts(All Channels)							
Max. Waveform Capture Rate	≥600,000 wfms/s							
Timebase Scale	5 ns/div~1 ks/div		2 ns/div~1 ks/div		1 ns/div~1 ks/div		500 ps/div~1 ks/div	
Vertical Sensitivity Range	1 mV/div to 10 V/div(1 MΩ); 1 mV/div to 1 V/div(50 Ω)							
DC Gain Accuracy	± 2% FullScale							
Waveform Record	≥450,000 wfms(1 CH)							
Trigger Type	Standard: Edge trigger, Pulse trigger, Slope trigger, Video trigger, Pattern trigger, Duration trigger, Timeout trigger, Runt trigger, Window trigger, Delay trigger, Setup/Hold trigger, and Nth Edge trigger Option: RS232, UART, I2C, SPI, CAN, FlexRay, LIN, I2S, and MIL-STD1553							
Decoding Type	Standard: Parallel Option: RS232, UART, I2C, SPI, LIN, CAN, FlexRay, I2S, and MIL-STD-1553							
Operation	A+B, A-B, AxB, A/B, FFT, A&&B, A  B, A^B, !A, Intg, Diff, Sqrt, Lg, Ln, Exp, Abs, and AX+B							
Auto Measurement	Vmax, Vmin, Vpp, Vtop, Vbase, Vamp, Vupper, Vmid, Vlower, Vavg, VRMS, Per. VRMS, Overshoot, Preshoot, Area, Period Area, and Std Dev, Period, Frequency, Rise Time, Fall Time, +Width, -Width, +Duty, -Duty, Positive Pulse Count, Negative Pulse Count, Rising Edge Count, Falling Edge Count, Tvmx, Tvmin, +Slew Rate, -Slew Rate, Delay(1↑-2↑), Delay(1↑-2↓), Delay(1↓-2↑), Delay(1↓-2↓), Phase(1↑-2↑), Phase(1↑-2↓), Phase(1↓-2↑), Phase(1↓-2↓)							
Enhanced FFT	Record Length	Max. 1 Mpts						
	Window Type	Rectangular (default), Blackman-Harris, Hanning, Hamming, Flattop, and Triangle.						
	Peak Search	a maximum of 15 peaks, confirmed by the settable threshold and offset threshold set by users						
Analysis	Frequency counter, DVM, power analysis, histogram							
Arbitrary Waveform Generator	25 MHz, 2CH(option, only for the MSO model)							
Connectivity	USB2.0 Host X 4, USB2.0 Device, LAN, HDMI 1.4b, TRIG OUT							
Display	10.1-inch capacitive multi-touch screen/gesture enabled operation							

## Ordering Information

Order Information	Order Number
<b>Models</b>	
MSO7054 (500 MHz, 10 GSa/s, 100 Mpts, 4+16 CH MSO)	MSO7054
MSO7034 (350 MHz, 10 GSa/s, 100 Mpts, 4+16 CH MSO)	MSO7034
MSO7024 (200 MHz, 10 GSa/s, 100 Mpts, 4+16 CH MSO)	MSO7024
MSO7014 (100 MHz, 5 GSa/s, 100 Mpts, 4+16 CH MSO)	MSO7014
DS7054 (500 MHz, 10 GSa/s, 100 Mpts, 4CH DS)	DS7054
DS7034 (350 MHz, 10 GSa/s, 100 Mpts, 4CH DS)	DS7034
DS7024 (200 MHz, 10 GSa/s, 100 Mpts, 4CH DS)	DS7024
DS7014 (100 MHz, 5 GSa/s, 100 Mpts, 4CH DS)	DS7014
<b>Standard Accessories</b>	
Power cord conforming to the standard of the destination country	-
USB cable	CB-USBA-USBB-FF-150
4 passive probes (500 MHz)	RP3500A
1 logic analyzer probe (only for MSO model)	RPL2316
Front panel cover	DS7000-FPC
<b>Recommended Accessories</b>	
Active differential probe (1.5 GHz BW)	RP7150
Active differential probe (800MHz BW)	RP7080
Rack mount kit	DS7000-RM
USB-GPIB interface converter	USB-GPIB
Near-field probe	NFP-3
Power analysis phase deviation correction jig	RPA246
Digital oscilloscope demonstration plate	DK-DS6000
<b>Bandwidth Upgrade Option</b>	
Bandwidth upgrades from 100 MHz to 200 MHz	DS7000-BW1T2
Bandwidth upgrades from 100 MHz to 350 MHz	DS7000-BW1T3
Bandwidth upgrades from 100 MHz to 500 MHz	DS7000-BW1T5
Bandwidth upgrades from 200 MHz to 350 MHz	DS7000-BW2T3
Bandwidth upgrades from 200 MHz to 500 MHz	DS7000-BW2T5
Bandwidth upgrades from 350 MHz to 500 MHz	DS7000-BW3T5
<b>Memory Depth Option</b>	
Maximum memory depth up to 250 Mpts	DS7000-2RL
Maximum memory depth up to 500 Mpts	DS7000-5RL
<b>Bundle Option</b>	
Function and application bundle option, including DS7000-COMP, DS7000-EMBD, DS7000-AUTO, DS7000-FLEX, DS7000-AUDIO, DS7000-AERO, MSO7000-AWG, DS7000-PWR	DS7000-BND
<b>Serial Protocol Analysis Option</b>	
PC serial bus trigger and analysis (RS232/UART)	DS7000-COMP
Embedded serial bus trigger and analysis (I2C, SPI)	DS7000-EMBD
Auto serial bus trigger and analysis (CAN, LIN)	DS7000-AUTO
FlexRay serial bus trigger and analysis (FlexRay)	DS7000-FLEX
Audio serial bus trigger and analysis (I2S)	DS7000-AUDIO
MIL-STD 1553 serial bus trigger and analysis (MIL-STD 1553)	DS7000-AERO
<b>Measurement Application Option</b>	
Dual-channel 25 MHz arbitrary waveform generator (only for MSO model)	MSO7000-AWG
Built-in power analysis	DS7000-PWR

Note: For all the mainframes, accessories and options, please contact the local office of **RIGOL**.

# MSO5000 Series Digital Oscilloscopes



MSO5000 series digital oscilloscope is a high-performance oscilloscope model designed based on RIGOL UltraVision II technology. With a 9-inch capacitive multi-touch screen, the MSO5000 series integrates 7 independent instruments into one, delivering super sample bandwidth ratio, extremely high memory depth, and other excellent specifications. Highly integrated ASIC chipset and innovative non relay front-end have prolonged the service life of the oscilloscope to a large extent, indirectly reducing

the usage cost for users. It is compact and portable in design, and all of the MSO5000 series (except MSO5152-E, it is a model dedicated for online sale and does not support the upgrade of the channel and bandwidth) products support the upgrade of the channels, bandwidths, and the analysis software. As it integrates many functions of multiple instruments, different user groups can have more choices in selecting their desired product based on their needs, helping them save their budget to a large extent while enjoying the superior test support and user experience.

- Analog bandwidth: 350 MHz, 200 MHz, 150MHz, 100 MHz, and 70 MHz; bandwidth upgrade option supported
- 2 or 4 analog channels (upgradable for all the MSO5000 series except MSO5152-E), standard 16 digital channels (need to buy LA probe)
- Up to 8 GSa/s real-time sample rate (4 GSa/s for MSO5152-E)
- Up to 200 Mpts memory depth (option)
- Up to 500,000 wfm/s capture rate (300,000 wfm/s for MSO5152-E)
- 41 measurement items; full-memory hardware measurement function
- A variety of serial protocol triggers and decodes
- 9-inch capacitive multi-touch screen, 256-level intensity grading display, with color persistence

## 7-into-1 Integrated Digital Oscilloscope



## Max. 500,000 wfms/s Capture Rate



## Hardware Full Memory Auto Measurement



## Hardware Waveform Recording and Playback



## Variety of Protocol Decodings

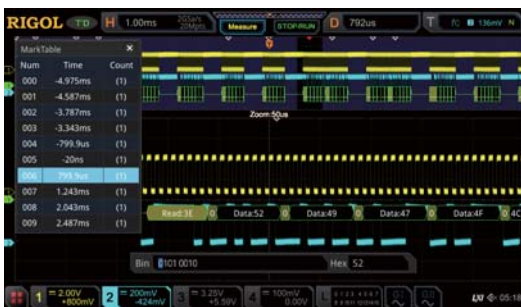

## Convenient Remote Control of Web Control

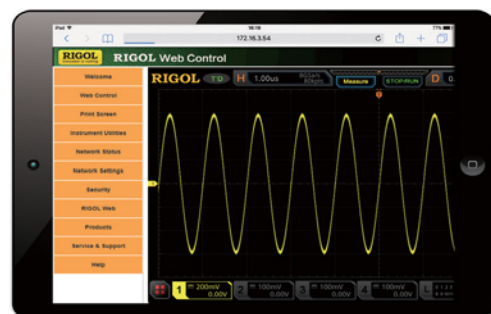

## Key Specifications

Model	MSO5072	MSO5074	MSO5102	MSO5104	MSO5204	MSO5354	MSO5152-E
Analog Bandwidth	70 MHz		100 MHz		200 MHz	350 MHz	150 MHz
	2	4	2	4	4	4	2
Channels	16 input digital channels (required to purchase PLA2216 active logic probe)						Single-channel arbitrary waveform generator (option activation software function, option MSO5000-E-AWG)
	Dual-channel arbitrary waveform generator (option activation software function, option MSO5000-AWG)						
Max. Sample Rate of Analog Channel	MSO5354/MSO5204/MSO5104/MSO5074: 8 GSa/s (single-channel), 4 GSa/s (half-channel <sup>[1]</sup> ), 2 GSa/s (all channels) MSO5102 and MSO5072: 8 GSa/s (single-channel), 2 GSa/s (all channels)						4 GSa/s (single-channel), 2 GSa/s (all channels)
Max. Memory Depth	Analog channel: 200 Mpts (single-channel), 100 Mpts (half-channel <sup>[1]</sup> ), 50 Mpts (all channels)						100 Mpts (single-channel), 50 Mpts (all channels)
	Digital channel: 25 Mpts (all channels)						
Max. Waveform Capture Rate <sup>[2]</sup>	≥500,000 wfms/s						≥300,000 wfms/s
Range of Time Base	5 ns/div~1 ks/div		5 ns/div~1 ks/div		2 ns/div~1 ks/div	1 ns/div~1 ks/div	5 ns/div~1 ks/div
Vertical Sensitivity Range	500 uV/div~10 V/div						
DC Gain Accuracy <sup>[3]</sup>	± 3% of full scale						
Hardware Real-time Waveform Recording and Playing	≥450,000 wfms (single-channel)						
Trigger Type	Standard: Edge trigger, Pulse trigger, Slope trigger, Video trigger, Pattern trigger, Duration trigger, Timeout trigger, Runt trigger, Window trigger, Delay trigger, Setup/Hold trigger, and Nth Edge trigger Option: RS232, UART, I2C, SPI, CAN, FlexRay, LIN, I2S, and MIL-STD1553						
Decoding Type	Standard: Parallel Option: RS232, UART, I2C, SPI, LIN, CAN, FlexRay, I2S, and MIL-STD-1553						
Waveform Calculation	A+B, A-B, AxB, A/B, FFT, A&&B, A  B, A^B, !A, Intg, Diff, Sqrt, Lg, Ln, Exp, Abs, AX+B, LowPass, HighPass, BandPass, and BandStop						
Auto Measurement	41 auto measurements; and up to 10 measurements can be displayed at a time						
Enhanced FFT	Record Length	Max. 1 Mpts					
	Window Type	Rectangular, Blackman-Harris, Hanning (default), Hamming, Flattop, and Triangle.					
	Peak Search	a maximum of 15 peaks, confirmed by the settable threshold and offset threshold set by users					
Analysis	Frequency counter, DVM, power analysis, histogram						
Arbitrary Waveform Generator	25 MHz, 2CH (required to install the AWG option)						25 MHz, single-channel (required to install the AWG option)
Connectivity	USB2.0 Host x 1, USB2.0 Device, LAN(10/100/1000 Base-T), HDMI 1.4b, TRIG OUT						
LCD Size and Type	9-inch capacitive multi-touch screen/gesture enabled operation						

Note: [1]: Half-channel mode: CH1 and CH2 are considered as a group; CH3 and CH4 are considered as another group. Each group share the same sample rate 4 GSa/s, and either one of the channels in each group is enabled.

[2]: Maximum value. single-channel, 10 ns horizontal time base, input amplitude 4 div, sine wave signal with 10 MHz frequency. Others are default settings.

[3]: 1 mV/div and 2 mV/div are a magnification of 4 mV/div setting. For vertical accuracy calculations, use full scale of 32 mV for 1 mV/div and 2 mV/div sensitivity setting.

## Ordering Information

Order Information	Order No.
<b>Models</b>	
MSO5354 (350 MHz, 8 GSa/s, 100 Mpts, 4+16 CH MSO)	MSO5354
MSO5204 (200 MHz, 8 GSa/s, 100 Mpts, 4+16 CH MSO)	MSO5204
MSO5104 (100 MHz, 8 GSa/s, 100 Mpts, 4+16 CH MSO)	MSO5104
MSO5102 (100 MHz, 8 GSa/s, 100 Mpts, 2+16 CH MSO)	MSO5102
MSO5074 (70 MHz, 8 GSa/s, 100 Mpts, 4+16 CH MSO)	MSO5074
MSO5072 (70 MHz, 8 GSa/s, 100 Mpts, 2+16 CH MSO)	MSO5072
MSO5152-E (150 MHz, 4 GSa/s, 150 Mpts, 2+16 CH MSO)	MSO5152-E
<b>Standard Accessories</b>	
Power cord conforming to the standard of the destination country	-
USB cable	CB-USBA-USBB-FF-150
2 or 4 passive probes (350 MHz)	PVP2350
<b>Optional Accessories</b>	
16-channel logic analyzer probe (dedicated probe for MSO5000 series)	PLA2216
Front protective cover	MSO5000-FPC
Front protective cover	MSO5000-E-FPC <sup>[1]</sup>
Rack mount kit	MSO5000-RM
USB-GPIB interface converter	USB-GPIB
Near-field probe	NFP-3
Power analysis phase deviation correction jig	RPA246
Digital oscilloscope demonstration plate	DK-DS6000
<b>Bandwidth Upgrade Option(unavailable for MSO5152-E)</b>	
Bandwidth upgrades from 70 MHz to 100 MHz	MSO5000-BW0T1
Bandwidth upgrades from 70 MHz to 200 MHz	MSO5000-BW0T2
Bandwidth upgrades from 70 MHz to 350 MHz	MSO5000-BW0T3
Bandwidth upgrades from 100 MHz to 200 MHz	MSO5000-BW1T2
Bandwidth upgrades from 100 MHz to 350 MHz	MSO5000-BW1T3
Bandwidth upgrades from 200 MHz to 350 MHz	MSO5000-BW2T3
<b>Memory Depth Option</b>	
Maximum memory depth upgradable to 200 Mpts	MSO5000-2RL
Maximum memory depth upgradable to 100 Mpts	MSO5000-E-1RL <sup>[1]</sup>
<b>Channel Number Upgrade Option</b>	
Upgrade the number of analog channels to 4 (only available for the MSO5XX2 model excluding MSO5152-E)	MSO5000-4CH
<b>Bundle Option</b>	
Function and application bundle option, including MSO5000-COMP, MSO5000-EMBD, MSO5000-AUTO, MSO5000-FLEX, MSO5000-AUDIO, MSO5000-AERO, MSO5000-AWG, and MSO5000-PWR	MSO5000-BND
Function and application bundle option, including MSO5000-COMP, MSO5000-EMBD, MSO5000-AUTO, MSO5000-FLEX, MSO5000-AUDIO, MSO5000-AERO, MSO5000-E-AWG, and MSO5000-PWR	MSO5000-E-BND <sup>[1]</sup>
<b>Serial Protocol Analysis Option</b>	
PC serial bus trigger and analysis (RS232/UART)	MSO5000-COMP
Embedded serial bus trigger and analysis (I2C and SPI)	MSO5000-EMBD
Auto serial bus trigger and analysis (CAN and LIN)	MSO5000-AUTO
FlexRay serial bus trigger and analysis (FlexRay)	MSO5000-FLEX
Audio serial bus trigger and analysis (I2S, only available for the MSO5XX4 model or the model installed with the MSO5000-4CH option)	MSO5000-AUDIO
MIL-STD-1553 serial bus trigger and analysis (MIL-STD-1553)	MSO5000-AERO
<b>Measurement Application Option</b>	
Dual-channel 25 MHz arbitrary waveform generator	MSO5000-AWG
Single-channel 25 MHz arbitrary waveform generator	MSO5000-E-AWG <sup>[1]</sup>
Built-in power analysis	MSO5000-PWR

[1] Note: Only available for MSO5152-E

# MSO/DS2000A Series Digital Oscilloscopes



MSO/DS2000A Series is the new mainstream digital scope to meet the customer's applications with its innovative technology. It provides bandwidth from 100MHz to 300MHz, sample rate up to 2GSa/s, and 2+16 channels, targeting for the embedded design and test market with its industry leading specifications, powerful trigger functions and broad analysis capabilities.

- Bandwidth up to 300MHz, standard with 50Ω input
- Two analog channels and 16 digital channels (MSO)
- Lower noise floor, wider vertical range (500uV/div ~ 10V/div)
- Waveform capture rate up to 50,000 wfms/s
- Built-in 2 CH and 25MHz Waveform generator (-S model)
- A variety of trigger and serial bus decoding functions

Wider vertical range, lower noise floor, better for small signal capturing

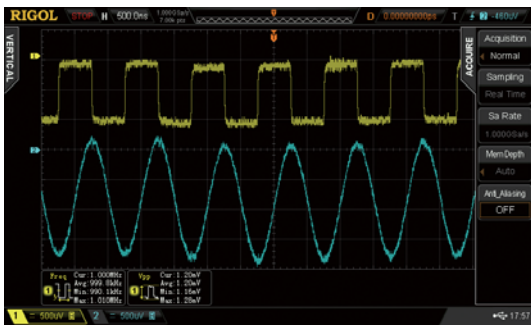

Serial bus Trigger&Decoding functions

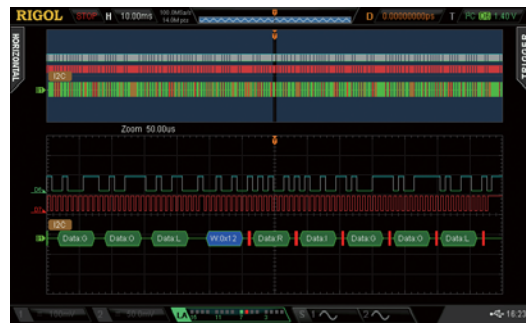

Realtime waveform record, replay, analysis function (std.)



Easy to be grouped and labeled for digital channels

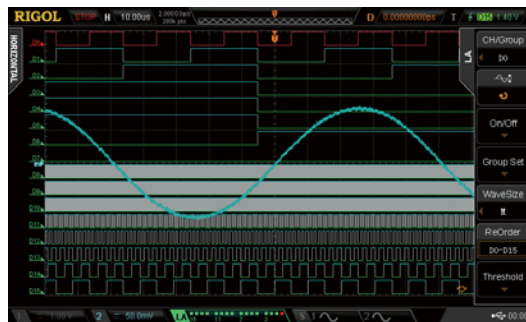

256 level intensity grading display



Built-in 2CH and 25MHz Source (-S model)

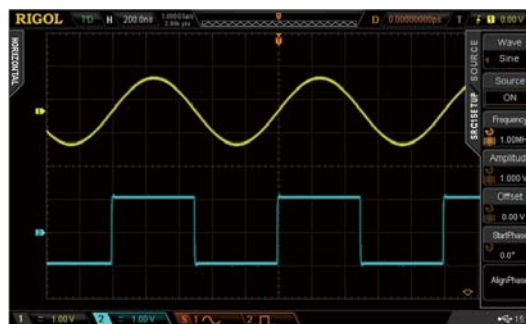



## Key Specifications

Model	DS2302A	MSO2302A-S	DS2202A	MSO2202A-S	DS2102A	MSO2102A-S
	MSO2302A		MSO2202A		MSO2102A	
Analog BW	300MHz		200MHz		100MHz	
Analog Channels	2					
Digital Channels	16 (only MSO)					
Sample rate	Analog Channel: Max. 2 GSa/s single channel, 1 GSa/s dual channel; Digital Channel: 1GSa/s(8 CH), 500MSa/s(16 CH)					
Memory Depth	Analog channel: 7Mpts(2 CH) / 14Mpts( 1 CH) std.;28Mpts(2 CH) / 56Mpts( 1 CH) opt.; Digital channel: 7Mpts(16 CH) / 14Mpts(8 CH) std.;14Mpts(16 CH) / 28Mpts(8 CH) opt.					
Waveform Capture rate	50,000wfms/s					
Timebase Scale	1ns/div to 1000s/div		2ns/div to 1000s/div		5ns/div to 1000s/div	
Input Impedance	Analog channel: (1MΩ±1%)    (16 pF±3 pF) or 50Ω±1.5%; Digital channel: (101kΩ±1%)    (8 pF±2 pF)					
Vertical Scale	Analog channel: 500 uV/div to 10 V/div(1 MΩ); 500 uV/div to 1 V/div(50 Ω); Digital channel: Threshold per set of 8 channels, User-defined threshold range ±20V in 10mV step					
DC Gain Accuracy	±2% full scale					
Waveform Record	Up to 65, 000 Frames					
Std. trigger functions	Edge, Pulse , Runt, Slope, Video, Pattern, Setup/Hold, RS232/UART,I2C,SPI					
Opt. trigger functions	Windows, Nth Edge, HDTV, Delay, Time Out, Duration, USB, CAN					
Serial Bus decoding	Standard: Parallel Bus (only MSO) ; Optional: RS232/UART, I2C, SPI, CAN					
Math functions	Analog channel: A+B,A-B,AxB,A/B,FFT,Digital Filter,Advanced Math,Logic operation;Digital channel: Logic operation					
Auto Measurements	Analog channel: 29 types; Digital channel: 12 types					
Connectivity	USB Host, USB Device, LAN (LXI) , AUX, support USB-GPIB (Opt.)					
Display	8.0 inches WVGA(800X480) LCD display, 256-level intensity grading display					

Built in 2CH 25MHz Function/Arb Generator (MSO/DS2xx2A-S)

Channels	Sample Rate	Vertical Resolution	Max. Output Frequency	Amplitude Range	Waveform Length	Output Waveforms
2	200MSa/s	14bits	25MHz	20mVpp-5Vpp ( High Z )	16K	Standard Waveforms: Sine, Square, Ramp, Pulse, Noise, DC Arbitrary Waveforms: Sinc, ExpRise, ExpFall, ECG, Gauss, Lorentz, Haversine ,User Defined

## Ordering Information

	Description	Order Number
Models	DS2102A (100MHz, 2CH Scope)	DS2012A
	MSO2102A (100MHz, 2+16 CH MSO)	MSO2012A
	MSO2102A-S (100MHz, 2+16 CH MSO + 25MHz, 2CH Source)	MSO2012A-S
	DS2202A (200MHz, 2CH Scope)	DS2022A
	MSO2202A (200MHz, 2+16 CH MSO)	MSO2022A
	MSO2202A-S (200MHz, 2+16 CH MSO + 25MHz, 2CH Source)	MSO2022A-S
	DS2302A (300MHz, 2CH Scope)	DS2302A
	MSO2302A (300MHz, 2+16 CH MSO)	MSO2302A
	MSO2302A-S (300MHz, 2+16 CH MSO + 25MHz, 2CH Source)	MSO2302A-S
Standard Accessories	2 passive probes (1X:35MHz / 10X:350MHz BW)	PVP2350
	1 LA probe(MSO only)	RPL2316
	Power cord conforming to the standard of the destination country	-
	USB cable	CB-USBA-USBB-FF-150
Deep Memory Option	Analog channel memory depth upgraded up to 56 Mpts Digital channel(MSO) memory depth upgraded up to 28 Mpts	MEM-DS2000
Advanced Trigger Option	Windows, Nth Edge, HDTV, Delay, Time Out, Duration, USB	AT-DS2000
Optional kit	Including: MEM-DS2000, AT-DS2000, SD-DS2000, CAN-DS2000A	BND-MSO/DS2000A

For probes and optional accessories, please refer to "Probes & Accessories Guide".

For decoding options, please refer to "Bus Analysis Guide".

# DS1000Z-E Series Digital Oscilloscopes

DS1000Z-E series digital oscilloscope is designed by RIGOL based on the mainstream demand. It is a high-performance and economic digital oscilloscope dedicated for e-commerce platform.



UltraVision

- Analog channel bandwidth: 200 MHz (DS1202Z-E): 100 MHz (DS1102Z-E)
- 2 analog channels
- Real-time sample rate up to 1 GSa/s
- Memory depth up to 24 Mpts (Std.)
- Up to 30,000 wfms/s waveform capture rate
- Up to 60,000 frames hardware real-time waveform recording and playback functions
- Innovative "UltraVision" technology
- Various trigger and bus decoding functions
- Low noise floor, vertical scale range: 500uV/div to 10 V/div
- Various interfaces: USB Host&Device, LAN (LXI), AUX
- Novel and delicate industrial design, easy to use
- 7-inch WVGA (800x480) TFT LCD, intensity graded color display

## 30,000 wfms/s Waveform Capture Rate



30,000 wfms/s waveform capture rate makes it easier to catch occasional abnormal signals.

## Hardware Waveform Recording and Playback Functions



Provide waveform recording option, record waveform changes, playback the waveforms easily, and locate the faults accurately.

## Digital Fluorescent Display

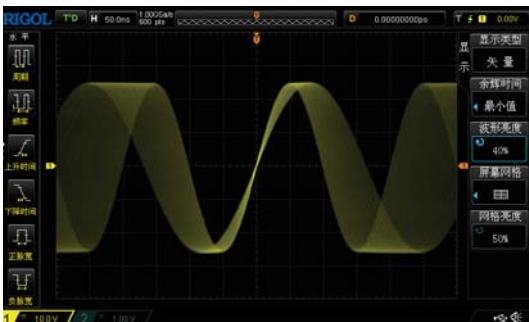

The intensity graded color display capability provides the fluorescent display effect, making the waveform changes obviously to be seen.

## 24M Memory Depth



Standard 24M memory depth. It allows users to give full consideration to the overall situation and details of the waveforms, maintain the highest sampling rate for a long period of time without missing any waveform changes.

## Serial Bus Trigger and Decoding Functions



Provide bus trigger and decoding options, support RS232/UART, I2C, SPI bus.

## Key Specifications

Model	DS1202Z-E	DS1102Z-E
Analog BW	200 MHz	100 MHz
Analog Channels	2	
Max. Sample Rate	1 GSa/s (single-channel), 500 Msa/s (dual-channel)	
Max. Memory Depth	24 Mpts (single-channel), 12 Mpts (dual-channel)	
Max. Waveform Capture Rate	30,000 wfms/s	
Hardware real-time waveform recording and playback functions	Up to 60,000 frames can be recorded.	
Timebase Scale	2 ns/div to 50 s/div	
Input Impedance	(1 MΩ±1%)    (15 pF±3 pF)	
DC Gain Accuracy	<10 mV: ±4% of full scale ≥10 mV: ±3% of full scale	
Vertical Scale (Probe ratio is 1X)	500uV/div to 10 V/div	
Standard Trigger Function	Edge, Pulse, Slope, Video, Pattern, Duration, Setup/Hold, RS232/UART, I2C, SPI, Runt, Window, Nth Edge, Delay trigger, and Timeout	
Bus Decoding	Parallel decoding; serial bus decoding: RS232, I2C, and SPI	
Waveform Operation	A+B, A-B, AxB, A/B, FFT, A&&B, A  B, A^B, !A, Intg, Diff, Sqrt, Lg, Ln, Exp, Abs, and Filter	
Auto Measurement	Period, Frequency, Rise Time, Fall Time, Positive Pulse Width, Negative Pulse Width, Positive Duty Cycle, Negative Duty Cycle, tVmax, tVmin, Positive Rate, Negative Rate, Delay $f_{1\rightarrow 2}$ , Delay $\tau_{1\rightarrow 2}$ , Phase $f_{1\rightarrow 2}$ , Phase $\tau_{1\rightarrow 2}$ , Maximum, Minimum, Peak-Peak Value, Top Value, Bottom Value, Amplitude, Upper Value, Middle Value, Lower Value, Average, Vrms, Overshoot, Pre-shoot, Area, Period Area, Period Vrms, and Variance	
Interface	USB Host, USB Device, LAN, Aux Output (TrigOut/PassFail)	
Screen	7-inch WVGA (800x480), multi-level intensity grading display	

## Order Information

Description		Order No.
Model	DS1202Z-E (200 MHz, 2 analog channels)	DS1202Z-E
	DS1102Z-E (100 MHz, 2 analog channels)	DS1102Z-E
Standard Accessories	Power cord conforming to the standard of the destination country	-
	USB cable	CB-USBA-USBB-FF-150
	2 passive probes (350 MHz PVP2350, only available for DS1202Z-E)	PVP2350
	2 passive probes (150 MHz PVP3150, only available for DS1102Z-E)	PVP3150
Optional Accessories	Rack mount kit	RM-DS1000Z

Note: For all the mainframes, accessories and options, please contact the local office of RIGOL.

# DS1000Z Series Digital Oscilloscopes



DS1000Z Series is the high performance, economic level general purpose oscilloscope which provides 4 analog channels, the bandwidth from 50MHz to 200MHz, up to 1GSa/s sample rate. In particular, DS1202Z-E is dedicated for online sale. It has two analog channels, with the bandwidth of 200 MHz. With the Ultravision technical platform, the DS1000Z series has sustained its characteristics of deep memory and high capture rate, exhibiting its cost-effective advantages.

- Analog channel Bandwidth: 200 MHz, 100 MHz, 70 MHz, 50 MHz
- 2 or 4 analog channels, 16 digital channels(Only Plus model)
- Memory depth up to 24 Mpts
- Various trigger and bus decoding functions
- Built-in dual-channel 25 MHz source (-S model)
- Various interfaces: USB, LAN (LXI), AUX, GPIB (optional)

4 standard analog channels



Standard serial bus trigger and decoding functions

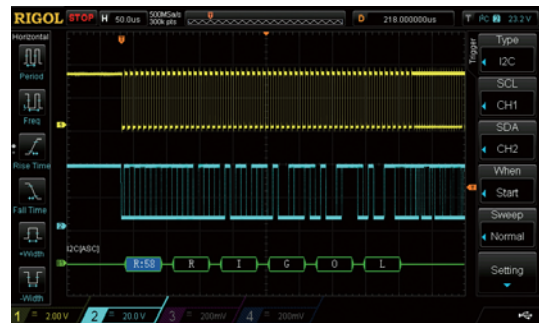

Intensity graded color display

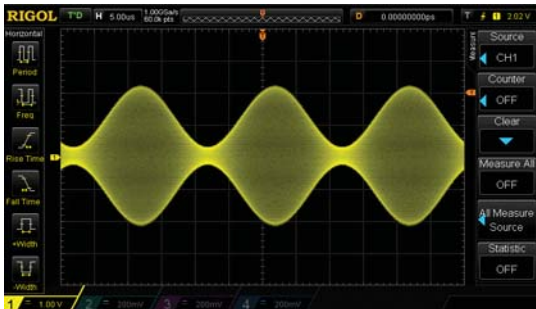

Mixed signal analysis with analog and digital channels

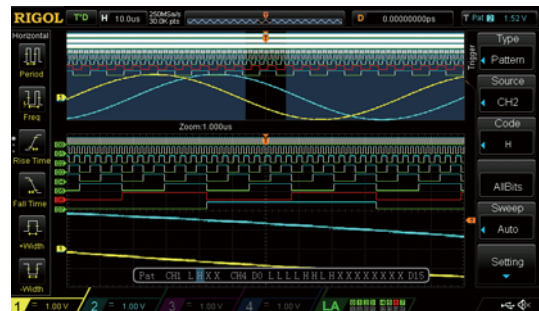

Deeper memory(Std.24Mpts)



Built-in dual-channel 25 MHz source (-S model)

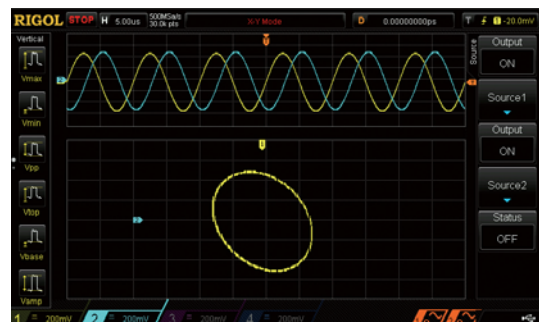

## Key Specifications

Model	DS1104Z Plus DS1104Z-S Plus	DS1074Z Plus DS1074Z-S Plus	DS1054Z			
Analog BW	100MHz	70MHz	50MHz			
Analog Channels	4					
Digital Channels(PLUS)	16	16	--			
Max. Sample Rate	Analog Channel:1GSa/s (1 CH),500MSa/s(2 CH),250MSa/s (3/4 CH); Digital Channel(only available for PLUS model):1GSa/s (8 CH),500MSa/s(16 CH)					
Max. Memory Depth	Analog Channel: 24Mpts(1 CH), 12Mpts (2 CH), 6Mpts (3/4 CH) . Digital Channel(only available for PLUS model): 24Mpts(8 CH) / 12Mpts(16 CH) .					
Max. Waveform Capture rate	30,000 wfms/s					
Timebase Scale	5 ns/div to 50 s/div					
Input Impedance	Analog Channel: (1MΩ±2%)  (13 pF±3 pF); Digital Channel(only available for PLUS model): (100kΩ±1%)  (8 pF±3 pF)					
Vertical Scale	Analog Channel: 1 mV/div to 10 V/div Digital Channel(only available for PLUS model): Threshold per set of 8 channels, User-defined threshold range ±15V in 10mV step					
DC Gain Accuracy	<10 mV: ±4% full scale ; ≥ 10 mV: ±3% full scale					
Real Time waveform Record and Analysis	Up to 60, 000 Frames					
Std. trigger functions	Edge, Pulse, Slope, Video, Pattern, Duration, Runt, Window, Nth Edge, Delay, Timeout, Setup/Hold, RS232/UART, I2C, SPI					
Bus decoding	Std: RS232/UART,I2C,SPI					
Math functions	A+B, A-B, AxB, A/B, FFT, A&&B, A  B, A^B, !A, Intg, Diff, Sqrt, Lg, Ln, Exp, Abs, Filter					
Auto Measurements	37 types					
Connectivity	USB Host (support USB-GPIB), USB Device, LAN(LXI), AUX (TrigOut/PassFail)					
Display	7.0-inch WVGA(800x480) TFT LCD display, 64 intensity grading level					
DS1xx4Z-S Plus, 25MHz Function/Arbitrary Waveform Generator						
Channels	Max. Sample Rate	Vertical Resolution	Max. Frequency	Amplitude Range	Waveform Length	Output Waveforms
2	200MSa/s	14 bits	25MHz	20 mVpp-5 Vpp	16 K	Sine, Square, Ramp, Pulse, Noise, DC, Sinc, Exponential Rise, Exponential Fall, ECG,Gauss, Haversine, User defined

## Ordering Information

	Description	Order Number
Models	DS1054Z (50 MHz, 4 CH)	DS1054Z
	DS1074Z Plus (70 MHz, 4 CH; MSO ready)	DS1074Z Plus
	DS1074Z-S Plus (70 MHz, 4 CH, 2-ch 25 MHz source; MSO ready)	DS1074Z-S Plus
	DS1104Z Plus (100 MHz, 4 CH; MSO ready)	DS1104Z Plus
	DS1104Z-S Plus (100 MHz, 4 CH, 2-ch 25 MHz source; MSO ready)	DS1104Z-S Plus
Standard Accessories	Power cord conforming to the standard of the destination country	-
	USB cable	CB-USBA-USBB-FF-150
	4 passive probes (1X:20MHz / 10X:150MHz BW) <sup>[1]</sup>	PVP3150
Standard Option	Memory depth option	MEM-DS1000Z
	Waveform recording option	REC-DS1000Z
	Serial protocol analysis option	SA-DS1000Z
	Advanced trigger option	AT-DS1000Z
RPL1116	MSO upgrade for DS1000Z Plus only	RPL1116

For probes and optional accessories, please refer to "Probes & Accessories Guide".

[1] Note: available for 4CH model.

# DS1000E Series Digital Oscilloscopes

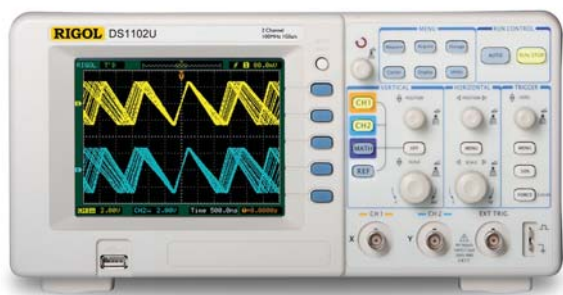

DS1000E series are the high-performance, economic digital oscilloscopes. They are widely used in the areas of education, training, production line, research and development.

- 1GSa/s maximum real-time sample rate
- Up to 1Mpts Memory depth
- Abundant trigger types: edge, pulse width, slope, video, alternate
- Standard with Pass/Fail test
- Compact and portable

## Key Specifications

Model	DS1102E	DS1052E
Bandwidth	100MHz	50MHz
Channels	2 + EXT	
Real-time Sample Rate	1GSa/s single channel, 500MSa/s dual-channel	
Memory Depth	Max. 1Mpts	
Timebase Range	2ns/div-50s/div	5ns/div-50s/div
Input Impedance	1MΩ    15pF	
Vertical Scale	2mV/div-10V/div	
Rise Time	<3.5ns	<7ns
Trigger Types	edge, pulse, slope, video, alternate	

## Ordering Information

	Description	Order Number
Models	DS1102E (100MHz, 1Mpts, 2CH)	DS1102E
	DS1052E (50MHz, 1Mpts, 2CH)	DS1052E
Standard Accessories	1 passive probe (1X:20MHz / 10X:150MHz BW) for each analog channel	PVP3150
	Power cord conforming to the standard of the destination country	-

# Bus Analysis Guide

Serial bus like I2C, SPI, UART/RS232, USB are widely used in electronic and telecom products as well as other embedded devices. RIGOL mainstream oscilloscope provides commonly used bus analysis functions. The scope can trigger the at start frame, end frame,

specific address and/or data, as well as error frame. Also, the scope can finish bus decoding functions which can help users to discover errors, debug hardware and accelerate development easily, so as to guarantee quick and high-quality accomplishment of projects.

Series and Options	Decoding Buses	Channel	I2C		SPI		RS232/UART		CAN		LIN		FlexRay		I2S		MIL-STD 1553	
			Trigger	Decode	Trigger	Decode	Trigger	Decode	Trigger	Decode	Trigger	Decode	Trigger	Decode	Trigger	Decode	Trigger	Decode
DS8000-R Series	4	Analog																
DS8000-R-COMP							○	○										
DS8000-R-EMBD			○	○	○	○												
DS8000-R-AUTO									○	○	○	○						
DS8000-R-FLEX												○	○					
DS8000-R-AUDIO														○	○			
DS8000-R-AERO																○	○	
MSO8000 Series	4	Analog & Digital																
MSO8000-COMP							○	○										
MSO8000-EMBD			○	○	○	○												
MSO8000-AUTO									○	○	○	○						
MSO8000-FLEX												○	○					
MSO8000-AUDIO														○	○			
MSO8000-AERO																○	○	
MSO/DS7000 Series	4	Analog & Digital																
DS7000-COMP							○	○										
DS7000-EMBD			○	○	○	○												
DS7000-AUTO									○	○	○	○						
DS7000-FLEX												○	○					
DS7000-AUDIO														○	○			
DS7000-AERO																○	○	
MSO5000 Series	2	Analog & Digital																
MSO5000-COMP							○	○										
MSO5000-EMBD			○	○	○	○												
MSO5000-AUTO									○	○	○	○						
MSO5000-FLEX												○	○					
MSO5000-AUDIO														○	○			
MSO5000-AERO																○	○	
MSO/DS2000A Series	2	Analog & Digital	●		●		●											
SD-DS2000				●		●		●										
CAN-DS2000A									●	●								
BND-MSO/DS2000A				●		●		●	●	●								
DS1000Z/-E Series	2	Analog & Digital	●	●	●	●	●	●										
DS1000Z Series	2	Analog & Digital	●	●	●	●	●	●										

● Standard      ○ Option, could be used

# Power Measurement and Analysis

Power supply is an important component of electronic devices. The quality of power supply will have direct influences on the electronic devices. During the design and manufacture of power supply, performance testing becomes more and more important. Ultra Power Analyzer is a power measurement and analysis software. The software along with RIGOL digital oscilloscope, high voltage differential probe, current probe, probe deskew fixture, and passive probe, form a complete power measurement system for power supply design and testing. It can analyze switching power supply efficiency and reliability.

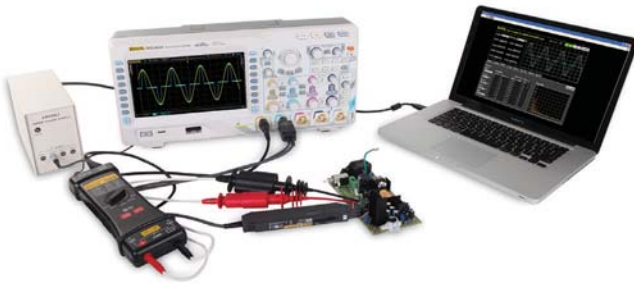

- Power quality analysis
- Current harmonics analysis
- Inrush current analysis
- Power device analysis
- Safe operating area analysis
- Modulation analysis
- Output analysis

Power quality analysis



Safe operating area analysis



Power device switching loss analysis

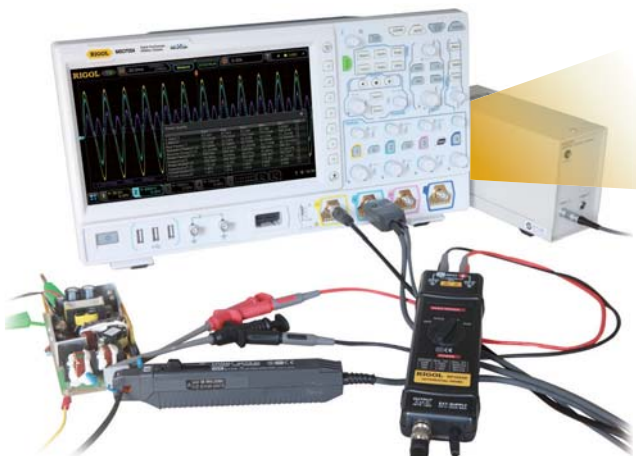

DS8000-R, MSO8000series, MSO/DS7000 series and MSO5000 series oscilloscopes support the optional built-in power analysis software, which can complete the power quality analysis and ripple analysis. The power analysis software can help engineers analyze the commonly used power parameters rapidly and accurately, without needing to make tedious configurations manually or do complicated formula calculation.



## Recommended Configuration

	Description	Order Number
Scope	DS8000-R, MSO8000, MSO/DS7000, MSO5000, MSO/DS2000A , DS1000Z and DS1000Z-E Series	
Accessories	High Voltage Differential Probe (depend on bandwidth and voltage range in practical application)	RP1000D Series
	Current Probe (depend on bandwidth and current range in practical application)	RP1000C Series
	1:1 Passive HighZ Probe (selected based on measured bandwidth)	PVP3150/PVP2350
PC Software	Ultra Power Analyzer	UPA-DS
Measurement Application Option	Built-in Power Analysis (only available for MSO/DS7000 series)	DS7000-PWR
	Built-in Power Analysis (only available for MSO5000 series)	MSO5000-PWR
	Built-in power analysis(only available for MSO8000 series)	MSO8000-PWR
	Built-in Power Analysis (only available for DS8000-R series, required to purchase the RPA246 phase deviation correction jig)	DS8000-R-PWR

## Active Differential Probe



## Active Single-Ended Probe



## High-Voltage Probe



# Current Probe



# High Voltage Differential Probe



# Probes & Accessories Guide

Models	Descriptions	DS8000-R	MSO8000	MSO/DS7000	MSO5000	MSO/DS2000A	DS1000Z/-E	DS1000E
PVA7250	2.5 GHz active differential probe, 30 Vp, CATI	○	○	○				
RP7150	1.5GHz Differential/Single ended probe, 30Vp, CATI	○	○	○				
RP7150S	1.5GHz Single ended probe, 30Vp, CATI	○	○	○				
RP7080	800MHz Differential/Single ended probe, 30Vp, CATI	○	○	○				
RP7080S	800MHz Single ended probe, 30Vp, CATI	○	○	○				
RP6150A	1.5GHz Low Z probe		● <sup>①</sup>	○				
RP5600A	600MHz high Z probe 10X	○	○	○				
RP3500A	500MHz high Z probe 10X		●	●		○	○	○
PVP2350	1X:35MHz / 10X:350MHz high Z probe	○	○	○	●	●	● <sup>②</sup>	○
PVP3150	1X:20MHz / 10X:150MHz high Z probe	○	○	○	○	○	●	●
RP1300H	DC-300MHz, 2000V CATI, 1500V CATII (DC+AC)	○	○	○	○	○	○	○
RP1010H	High voltage probe, DC-50MHz, DC:10KV, AC:pulse≤ 20KVpp, sine≤ 7KVrms	○	○	○	○	○	○	○
RP1018H	High Voltage Probe, DC-150MHz, DC+AC:18KVp CATII, AC:12KVrms CATII	○	○	○	○	○	○	○
RP1025D	High voltage differential Probe, DC-25MHz, Vmax ≤ 1400Vpp	○	○	○	○	○	○	○
RP1050D	High voltage differential Probe, DC-50MHz, Vmax ≤ 7000Vpp	○	○	○	○	○	○	○
RP1100D	High voltage differential Probe, DC-100MHz, Vmax ≤ 7000Vpp	○	○	○	○	○	○	○
PHA0150	High voltage differential Probe, DC-70MHz, Vmax ≤ 1500Vpp	○	○	○	○	○	○	○
PHA1150	High voltage differential Probe, DC-70MHz, Vmax ≤ 1500Vpp	○	○	○	○	○	○	○
RP1001C	Current probe,DC-300KHz, DC: ±100A, AC: 200App,70Arms	○	○	○	○	○	○	○
RP1002C	Current probe,DC-1MHz, DC: ±70A, AC: 140App, 50Arms	○	○	○	○	○	○	○
RP1003C	Current probe,DC-50MHz, Max. AC peak: 50A (Non-continuous), 30Arms. Must order power supply RP1000P	○	○	○	○	○	○	○
RP1004C	Current probe,DC-100MHz, Max. AC peak: 50A (non-continuous), 30Arms. Must order power supply RP1000P	○	○	○	○	○	○	○
RP1005C	Current probe,DC-10MHz, Max.150 Arms, 300 A peak (Non-continuous), 500 A peak (@pulse width <=30 ms). Must order power supply RP1000P.	○	○	○	○	○	○	○
PCA1030	Current probe, DC-50 MHz, Max. current: 50A (non-continuous), 30Arms, power supplied by oscilloscope host	○	○	○				
PCA2030	Current probe, DC-100 MHz, Max. current: 50A (non-continuous), 30Arms, power supplied by oscilloscope host	○	○	○				
PCA1150	Current probe, DC-10 MHz, Max. current: 150Arms, 300A (non-continuous),500Apeak, power supplied by oscilloscope host	○	○	○				
RPL2316	16-channel logic analyzer probe for MSO4000,MSO2000A series		○	● <sup>③</sup>		● <sup>④</sup>		
PLA2216	16-channel logic analyzer probe for MSO5000 series				○			
RPL1116	16-channel logic analyzer probe for MSO1000Z series						○	
T2R1000	Tekprobe to RIGOL scope adapter	○	○	○				
USB-GPIB	USB-GPIB Interface Converter	○	○	○	○	○	○	○
ADP0150BNC	50 ohm adapter(2W, 1GHz)				○		○	○

● Standard ○ Option ① Only available for MSO8204/MSO8104 ② Only available for DS1202Z-E ③ Only available for MSO7000 ④ Only available for MSO2000

# Spectrum Analyzers



RIGOL's RSA series (including RSA5000 series and RSA3000(E) series) are the first full-function real-time spectrum analyzers in China. Being equipped with the patented technology Ultra Real, it optimizes performance and price. The superb specifications and outstanding performance can be delivered both in the GPSA and RTSA working modes. With a 10.1" capacitive multi-touch screen with high resolution, it supports various touch gestures. You can also operate it with the externally connected keyboard and mouse. It has the built-in Linux system, and the HDMI interface is available for you to make the communication interface more stable and reliable. It can be widely applied to corporate R&D, factory production, education teaching, and other fields. With excellent performance at an unprecedented price point, the RSA series real-time spectrum analyzer allows you to further improve measurement quality at low costs.

DSA800 series, DSA800E series, and DSA700 series spectrum analyzers adopt the latest digital IF technology. These spectrum analyzer products cover different frequency ranges, and its frequency can reach up to 7.5 GHz, the Displayed Average Noise Level (DANL) as low as -161 dBm, phase noise below -98dBc/Hz, RBW 10 Hz. These specifications reach the international advanced level of the same product category. To meet the demands of different users, these spectrum analyzers are also equipped with standard and optional accessories, such as preamplifier (PA), tracking generator (TG), Vector Signal Analysis Measurement Application, EMI Measurement Application, advanced measurement kit (AMK), VSWR measurement kit, teaching kit, VSWR bridge, cables, and converters.

	Frequency Band							Max. RTBW	Min. RBW	Phase Noise (at 10 kHz offset)	Software					Hardware		
	0.5 GHz	1 GHz	1.5 GHz	3 GHz	3.2 GHz	4.5 GHz	6.5 GHz				7.5 GHz	Vector Signal Analysis Measurement Application	EMI Measurement Application	VNA	AMK	EMI	VSWR	TG
RSA5065/-TG/N							•	40 MHz	1Hz	-108dBc/Hz	○	○	only N	○	•	•	-TG/N Model	○
RSA5032/-TG/N					•			40 MHz	1Hz	-108dBc/Hz	○	○	only N	○	•	•	-TG/N Model	○
RSA3045/-TG/N						•		40 MHz	1Hz	-102dBc/Hz		○	only N	○	○	•	-TG/N Model	○
RSA3030/-TG/N				•				40 MHz	1Hz	-102dBc/Hz		○	only N	○	○	•	-TG/N Model	○
RSA3030E/-TG				•				10 MHz	1Hz	-102dBc/Hz		○		○	○	•	-TG Model	○
RSA3015E/-TG			•					10 MHz	1Hz	-102dBc/Hz		○		○	○	•	-TG Model	○
RSA3015N			•					40 MHz	1Hz	-102dBc/Hz		○	•	○	○	•	N Model	○
DSA875/-TG							•		10Hz	-98dBc/Hz				○	○	○	-TG Model	•
DSA832/-TG					•				10Hz	-98dBc/Hz				○	○	○	-TG Model	•
DSA832E/-TG					•				10Hz	-90dBc/Hz				○	○	○	-TG Model	•
DSA815/-TG			•						10Hz	-80dBc/Hz				○	○	○	-TG Model	•
DSA710		•							100Hz	-80dBc/Hz				○	○		without	•
DSA705	•								100Hz	-80dBc/Hz				○	○		without	•

• Standard ○ Option

# RSA5000 Series Spectrum Analyzers



The RSA5000 series real-time spectrum analyzer includes six models: RSA5065, RSA5065-TG, RSA5032, RSA5032-TG, RSA5065N, and RSA5032N. The -TG model is equipped with the tracking generator. The frequency band range: 9 kHz to 3.2 GHz; 9 kHz to 6.5 GHz. With the technical platform Ultra Real, it provides five modes (GPSA, RTSA, EMI, VNA, and VSA) to deliver excellent performance and best specifications. In RTSA mode, it can seamlessly capture the transient signal, and display the measurement results completely in the Density view, Spectrum view, etc. The FMT trigger mode allows you to accurately capture the signal of interest. VSA mode enables the RSA5000 series real-time spectrum analyzer to make comprehensive and detailed analysis and measurement of vector

signals in multiple dimensions in the time domain, frequency domain, and modulation domain. EMI measurement application software allows users to perform pre-compliance test and diagnosis evaluation before formal EMI certification for the product.

The VNA mode enables users to make S11, S21, and DTF measurements for the components and circuit networks. The network characteristics of the components under test can be accurately demonstrated in Smith chart, Polar chart, and other formats.

- Ultra-Real technology
- Frequency: up to 6.5 GHz
- Displayed average noise level (DANL): <-165 dBm (typical)
- Phase noise: <-108 dBc/Hz (typical)
- Level measurement uncertainty: <0.8 dB
- 6.5 GHz tracking generator
- Min. RBW 1 Hz
- Up to 40 MHz real-time analysis bandwidth
- Multiple measurement modes
- Various measurement functions
- Vector signal analysis application software (option)
- EMI measurement application software (option)
- Vector network analysis software
- Multiple trigger modes and trigger masks
- Density, Spectrogram, and other display modes
- PC software options
- 10.1" capacitive multi-touch screen/gesture enabled operation
- USB, LAN, HDMI and other communication and display interfaces

## Built-in VNA mode (N model)



In VNA mode, you can make S11, S21, and DTF measurements for the components and circuit networks. The network characteristics of the components under test can be accurately demonstrated in Smith chart, Polar chart, and other formats.

## Discover Transient Anomalies Through Ultra Real

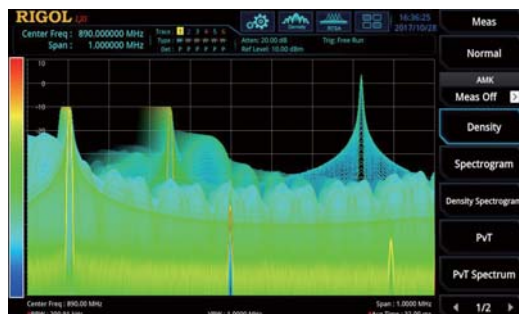

The RSA5000 series delivers up to 40MHz of real-time bandwidth using the original Ultra Real technology. In the real-time bandwidth range, transient signals exceeding 7.45us duration can be guaranteed to be 100% captured and accurately measured.

## Discover Problems in Design with Vector Analysis



The VSA supports a variety of digital modulation formats such as QAM, PSK, MSK, ASK, FSK, etc. This function is used to quickly demodulate and display multi-dimensional data such as its constellation, eye diagram (baseband signal), spectrogram, demodulation data, etc., to discover problems in the design.

## Conduction/radiation Pre-testing with Built-in EMI Test



The RSA5000's built-in EMI pre-test application software, combined with CISPR-compliant filters, pre-tests the product for conduction and radiation to identify and improve its conduction/radiation disturbance source and accelerate time-to-market.

## Signal Triggering and Monitoring Via FMT Template

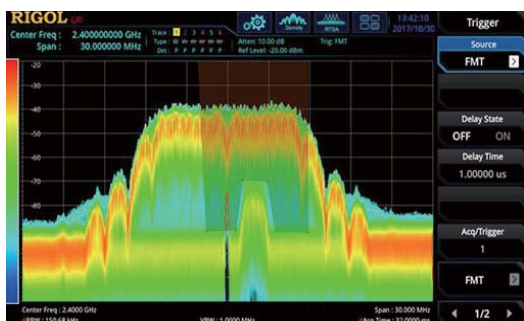

The FMT frequency mask trigger is a unique trigger mode for real-time spectrum analyzers. You can quickly build a template and accurately locate and trigger signals that match the template rules to detect sporadic anomalies within the monitored range.

## Quickly Complete Operations with a Multi-touch Screen



You can use the RSA5000 series to provide a 10.1-inch capacitive multi-touch screen for quick setup, and support a variety of gestures such as dragging, expanding, and zooming waveforms to provide a personalized interactive experience that maximizes your time.

## Multiple Interfaces to Improve the Connectivity of the Instruments



The instrument can be connected to a larger display/monitor via the HDMI interface for better display effects. The Web Control function allows you to directly control the device by accessing the device IP address, improving the experience of remote control.

## Excellent Phase Noise Metric

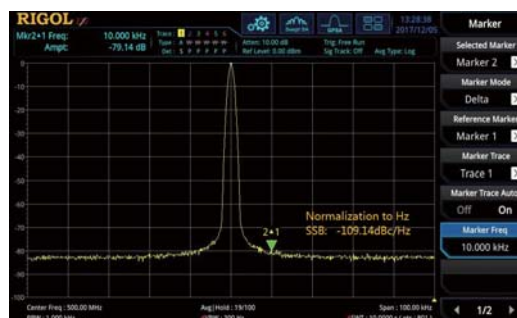

Excellent sweep performance, phase noise as low as -108 dBc/Hz

## Key Specifications

Model	RSA5032/-TG/N	RSA5060/-TG/N
Frequency Range	9 kHz to 3.2 GHz	9 kHz to 6.5 GHz
Frequency Stability	0°C to 50°C , with the reference 25°C	
	Standard	<0.5 ppm
	Option OCXO-C08	<0.005 ppm
Phase Noise (at 10 kHz offset)	10 kHz, $f_c = 500$ MHz	<-106 dBc/Hz, <-108 dBc/Hz (typical)
Resolution Bandwidth (-3 dB)	1 Hz to 10 MHz, in 1-3-10 sequence	
Resolution Bandwidth (-6 dB)	200 Hz, 9 kHz, 120 kHz, 1 MHz	
Displayed Average Noise Level (DANL)	preamp on, attenuation = 0 dB, sample detector, trace averages $\geq 50$ , tracking generator off, normalized to 1 Hz, 20°C to 30°C , input impedance = 50 $\Omega$ . <-162 dBm, <-165 dBm (typical)	
Level Measurement Uncertainty	0.8 dB (nominal)	
TG Frequency Range (only available for RSA5032-TG/N and RSA5065-TG/N)	100 kHz to 3.2 GHz	100 kHz to 6.5 GHz
TG Output Level Range (only available for RSA5032-TG/N and RSA5065-TG/N)	-40 dBm to 0 dBm	-40 dBm to 0 dBm
Real-time Analysis Bandwidth or I/Q Demodulation Bandwidth	25 MHz, 40 MHz (Option RSA5000-B40)	

Full-scale Accuracy	maximum span; default Kaiser Window		
Min. signal duration for 100% POI at the full-scale accuracy	7.45 $\mu$ s		
Window Type	Hanning, Blackman-Harris, Rectangular, Flattop, Kaiser, Gaussian		
Max. Sample Rate	51.2 MSa/s		
FFT Rate 146,484/s (nominal)	146,484/s (nominal)		
SFDR	mixer level = -30 dBm		
	<-60 dBc/Hz (typical)		
Trigger Source	Free Run, External, Power, FMT		
VNA Mode (only available for RSA5032N and RSA5065N)	Meas Setup		
	Measurement Type	S11, S21, and DTF	
	Measurement Bandwidth	1 kHz~10 MHz (in 1-3-10 sequence)	
	Data Points	101~10001; default 201	
	Transmission Measurement S21		
	Trace Format	Lin Mag, Log Mag, Phase, Group Delay	
	Dynamic Range	S21, RBW=10 kHz, Port1 level=0 dBm, Log Mag, Average=50	
		80 dB (nom.)	
	Reflection Measurement S11		
	Trace Format	Lin Mag, Log Mag, Phase, Group Delay, SWR, Smith Chart (Lin/Phase, Log/Phase, Real/Imag, R+j*X, G+j*B), Polar Chart (Lin/Phase, Log/Phase, Real/Imag)	
	Corrected Directivity (With CK106A)	S11, Log Mag, Average=50	
>40 dB (nom.)			

## Order Information

	Description	Order No.
Model	Real-time Spectrum Analyzer, 9 kHz to 3.2 GHz	RSA5032
	Real-time Spectrum Analyzer, 9 kHz to 6.5 GHz	RSA5065
	Real-time Spectrum Analyzer, 9 kHz to 3.2 GHz (with tracking generator, factory installed)	RSA5032-TG
	Real-time Spectrum Analyzer, 9 kHz to 6.5 GHz (with tracking generator, factory installed)	RSA5065-TG
	Real-time Spectrum Analyzer, 9 kHz to 3.2 GHz (include TG and VNA)	RSA5032N
	Real-time Spectrum Analyzer, 9 kHz to 6.5 GHz (include TG and VNA)	RSA5065N
Standard Accessories	Power Cord	-
Option	Vector Signal Analysis Measurement Application	RSA5000-VSA
	EMI Measurement Application	RSA5000-EMI
	Preamplifier (PA)	RSA5000-PA
	Highly Stable Clock(Need to be installed before leaving the factory)	OCXO-C08
	Real-time/Analysis Bandwidth 40 MHz	RSA5000-B40
	Advanced Measurement Kit	RSA5000-AMK
	Spectrum Analyzer PC Software	Ultra Spectrum
EMI Pre-compliance Test Software	S1210 EMI Pre-compliance Software	

For optional options and accessories of other RF instruments, please refer to "Options and Accessories Guide" of the specified RF instrument.

# RSA3000 Series Spectrum Analyzers



The RSA3000 series real-time spectrum analyzer includes seven models: RSA3015N, RSA3030, RSA3030-TG, RSA3030N, RSA3045, RSA3045-TG, and RSA3045N. The -TG model is equipped with the tracking generator. The frequency band range: 9 kHz to 1.5 GHz; 9 kHz to 3 GHz; 9 kHz to 4.5 GHz. With the technical platform Ultra Real, it provides four modes (GPSA, RTSA, EMI, and VNA) to deliver excellent performance and best specifications. In RTSA mode, it can seamlessly capture the transient signal, and display the measurement results completely in the Density view, Spectrum view, etc. The FMT trigger mode allows you to accurately capture the signal of interest.

EMI measurement application software allows users to perform pre-compliance test and diagnosis evaluation before formal EMI certification for the product. The VNA mode enables users to make S11, S21, and DTF measurements for the components and circuit networks. The network characteristics of the components under test can be accurately demonstrated in Smith chart, Polar chart, and other formats.

- Ultra-Real technology
- Frequency: up to 4.5 GHz
- Displayed average noise level (DANL): <-161 dBm (typical)
- Phase noise: <-102 dBc/Hz (typical)
- Level measurement uncertainty: <1.0 dB
- 4.5 GHz tracking generator
- Min. RBW 1 Hz
- Up to 40 MHz real-time analysis bandwidth
- Various measurement functions
- EMI measurement application software (option)
- Vector network analysis software
- Multiple trigger modes and trigger masks
- Density, Spectrogram, and other display modes
- PC software options
- 10.1" capacitive multi-touch screen/gesture enabled operation
- USB, LAN, HDMI and other communication and display interfaces

## Built-in VNA mode (N model)



In VNA mode, you can make S11, S21, and DTF measurements for the components and circuit networks. The network characteristics of the components under test can be accurately demonstrated in Smith chart, Polar chart, and other formats.

## Conduction/radiation Pre-testing with Built-in EMI Test Software



The RSA3000's built-in EMI pre-test application software, combined with CISPR-compliant filters, pre-tests the product for conduction and radiation to identify and improve its conduction/radiation disturbance source and accelerate time-to-market.

## Signal Triggering and Monitoring Via FMT Template



The FMT frequency mask trigger is a unique trigger mode for real-time spectrum analyzers. You can quickly build a template and accurately locate and trigger signals that match the template rules to detect sporadic anomalies within the monitored range.

## Resolution Bandwidth As Low As 1 Hz

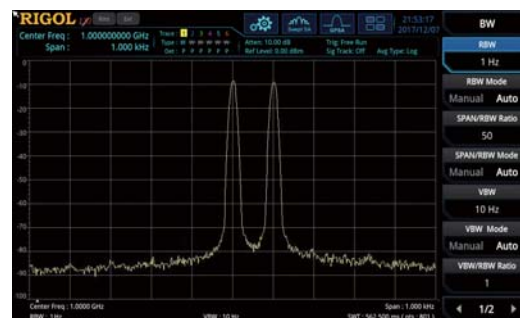

Resolving signals with similar frequencies is critical to verifying many RF devices and systems. With the RSA3000, the RBW resolution bandwidth with a scan bandwidth of only 1 Hz allows you to view more details of adjacent signals.



## DANL As Low As -161 dBm with Optional Preamp



View lower powered signals (harmonics, interference sources) and ease trouble-shooting in swept and real-time mode.

## Quickly Complete Operations with a Multi-touch Screen



The RSA3000 series provides a 10.1-inch capacitive multi-touch screen for quick setup, and supports a variety of gestures such as dragging, expanding, and zooming waveforms to provide a personalized interactive experience that maximizes your time.

## Multiple Interfaces to Improve the Connectivity of the Instruments



The instrument can be connected to a larger display/monitor via the HDMI interface for better display effects. The Web Control function allows you to directly control the device by accessing the device IP address, improving the experience of remote control.

## Excellent Phase Noise Metric

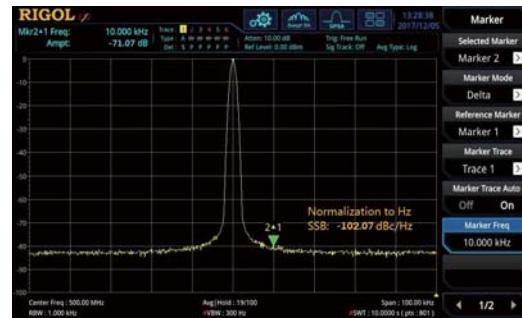

Excellent sweep performance, phase noise as low as -102 dBc/Hz

## Key Specifications

Model	RSA3015N	RSA3030/-TG/N	RSA3045/-TG/N
Frequency Range	9 kHz to 1.5 GHz	9 kHz to 3.0 GHz	9 kHz to 4.5 GHz
0°C to 50°C , with the reference 25°C			
Standard	<0.5 ppm		
Option OCXO-C08	<0.005 ppm		
10 kHz, $f_c = 500$ MHz	<-100 dBc/Hz, <-102 dBc/Hz (typical)		
Resolution Bandwidth (-3 dB)	1 Hz to 3 MHz (option 1 Hz to 10 MHz), in 1-3-10 sequence		
Resolution Bandwidth (-6 dB) (Option RSA3000-EMC)	200 Hz, 9 kHz, 120 kHz, 1 MHz		
Displayed Average Noise Level (DANL)	preamp on, attenuation = 0 dB, sample detector, trace averages $\geq 50$ , tracking generator off, normalized to 1 Hz, 20°C to 30°C , input impedance = 50 $\Omega$ . <-158 dBm, <-161 dBm (typical)		
Level Measurement Uncertainty	1.0 dB (nominal)		
TG Frequency Range (only available for RSA3015N, RSA3030-TG/N, and RSA3045-TG/N)	100 kHz to 1.5 GHz	100 kHz to 3 GHz	100 kHz to 4.5 GHz
TG Output Level Range (only available for RSA3015N, RSA3030-TG/N, and RSA3045-TG/N)	-40 dBm to 0 dBm	-40 dBm to 0 dBm	-40 dBm to 0 dBm
Real-time Analysis Bandwidth	Upgrade supported: 10 MHz (Std.) 25 MHz (Option RSA3000-B25) 40 MHz (Option RSA3000-B40)	25 MHz (Option RSA3000-B25) 40 MHz (Option RSA3000-B40)	
Full-scale Accuracy	maximum span; default Kaiser Window		
Min. signal duration for 100% POI at the full-scale accuracy	9.3 $\mu$ s 7.82 $\mu$ s (Option RSA3000-B25) 7.45 $\mu$ s (Option RSA3000-B40)		

Window Type	Hanning, Blackman-Harris, Rectangular, Flattop, Kaiser, Gaussian	
FFT Rate	146,484/s (nominal)	
SFDR	mixer level = -30 dBm <-50 dBc/Hz (typical)	
Trigger Source	Free Run, External, Power, FMT	
VNA Mode (only available for RSA5032N and RSA5065N)	<b>Meas Setup</b>	
	Measurement Type	S11, S21, and DTF
	Measurement Bandwidth	1 kHz~10 MHz (in 1-3-10 sequence)
	Data Points	101~10001; default 201
	<b>Transmission Measurement S21</b>	
	Trace Format	Lin Mag, Log Mag, Phase, Group Delay
	Dynamic Range	S21, RBW=10 kHz, Port1 level=0 dBm, Log Mag, Average=50 80 dB (nom.)
	<b>Reflection Measurement S11</b>	
	Trace Format	Lin Mag, Log Mag, Phase, Group Delay, SWR, Smith Chart (Lin/Phase, Log/Phase, Real/Imag, R+j*X, G+j*B), Polar Chart (Lin/Phase, Log/Phase, Real/Imag)
	Corrected Directivity (With CK106A)	S11, Log Mag, Average=50 >40 dB (nom.)

## Order Information

	Description	Order No.
Model	Real-time Spectrum Analyzer, 9 kHz to 3.0 GHz	RSA3030
	Real-time Spectrum Analyzer, 9 kHz to 4.5 GHz	RSA3045
	Real-time Spectrum Analyzer, 9 kHz to 3.0 GHz (with tracking generator, factory installed)	RSA3030-TG
	Real-time Spectrum Analyzer, 9 kHz to 4.5 GHz (with tracking generator, factory installed)	RSA3045-TG
	Real-time Spectrum Analyzer, 9 kHz to 1.5 GHz (include TG and VNA)	RSA3015N
	Real-time Spectrum Analyzer, 9 kHz to 3.0 GHz (include TG and VNA)	RSA3030N
	Real-time Spectrum Analyzer, 9 kHz to 4.5 GHz (include TG and VNA)	RSA3045N
Standard Accessories	Power Cord	-
Option	EMI Measurement Application (includes RSA3000-EMC)	RSA3000-EMI
	Preamplifier (PA)	RSA3000-PA
	Highly Stable Clock(Need to be installed before leaving the factory)	OCXO-C08
	RBW 1 Hz to 10 MHz	RSA3000-BW1
	Real-time/Analysis Bandwidth 25 MHz	RSA3000-B25
	Real-time/Analysis Bandwidth 40 MHz	RSA3000-B40
	Advanced Measurement Kit	RSA3000-AMK
	EMC Filter and Quasi-peak Detector Kit	RSA3000-EMC
	Spectrum Analyzer PC Software	Ultra Spectrum
	EMI Pre-compliance Test Software	S1210 EMI Pre-compliance Software

For optional options and accessories of other RF instruments, please refer to "Options and Accessories Guide" of the specified RF instrument.

# RSA3000E Series Spectrum Analyzer



The RSA3000E series real-time spectrum analyzer includes four models: RSA3015E, RSA3015E-TG, RSA3030E, and RSA3030E-TG. The -TG model is equipped with the tracking generator. The frequency band range: 9 kHz to 1.5 GHz; 9 kHz to 3 GHz. With the patented technology Ultra Real, it can deliver excellent performance and best specifications. Four modes are available: GPSA, RTSA, EMI, and VSA. The general-purpose spectrum analyzer may not fully capture the signal due to the deadtime and slow sweep, which may even result in signal loss. Compared with the general-purpose spectrum analyzer, the real-time spectrum analyzer can perfectly address this issue.

EMI measurement application software allows users to perform pre-compliance test and diagnosis evaluation before formal EMI certification for the product. The EMI mode enables users to perform EMI pre-compliance test that meets the CISPR standards. The VSA mode provides the analysis for the vector signal and displays several measurement analysis results, supporting only ASK and FSK.

- Ultra-Real technology
- Frequency: up to 3 GHz
- Displayed average noise level (DANL): <-161 dBm (typical)
- Phase noise: <-102 dBc/Hz (typical)
- Level measurement uncertainty: <1.0 dB
- 3 GHz tracking generator
- Min. RBW 1 Hz
- Up to 10 MHz real-time analysis bandwidth
- Multiple measurement modes
- Various measurement functions
- EMI measurement application software (option)
- Multiple trigger modes and trigger masks
- Density, Spectrogram, and other display modes
- PC software options
- 10.1" capacitive multi-touch screen/gesture enabled operation
- USB, LAN, HDMI and other communication and display interfaces

## Conduction/radiation Pre-testing with Built-in EMI Test Software



The RSA3000E's built-in EMI pre-test application software, combined with CISPR-compliant filters, pre-tests the product for conduction and radiation to identify and improve its conduction/radiation disturbance source and accelerate time-to-market.

## Resolution Bandwidth As Low As 1 Hz

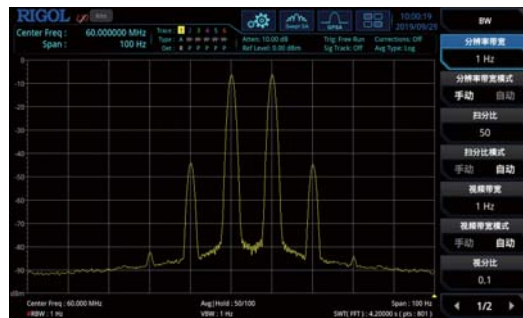

Resolving signals with similar frequencies is critical to verifying many RF devices and systems. With the RSA3000E, the RBW resolution bandwidth with a scan bandwidth of only 1 Hz allows you to view more details of adjacent signals.

## DANL As Low As -161 dBm with Optional Preamp



View lower powered signals (harmonics, interference sources) and ease trouble-shooting in swept and real-time mode.

## ASK/FSK Demodulation Analysis



ASK/FSK demodulation analysis software can help engineers demodulate and analyze signals such as TPMS, PKE/RKE, and obtain parameters of signal modulation quality to help products get listed quickly.

## Excellent Phase Noise Metric

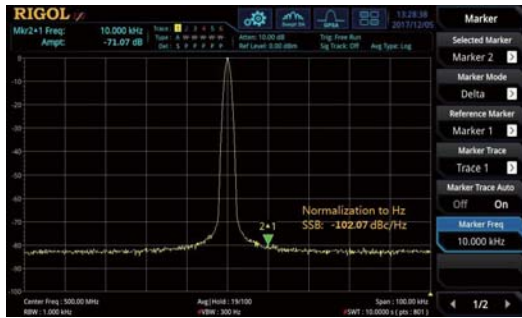

Excellent sweep performance, phase noise as low as -102 dBc/Hz

## Quickly Complete Operations with a Multi-touch Screen



The RSA3000E series provides a 10.1-inch capacitive multi-touch screen for quick setup, and supports a variety of gestures such as dragging, expanding, and zooming waveforms to provide a personalized interactive experience that maximizes your time.

## Key Specifications

Model	RSA3015E/RSA3015E-TG	RSA3030E/RSA3030E-TG
Frequency Range	9 kHz to 1.5 GHz	9 kHz to 3 GHz
Frequency Stability	0°C to 50°C, with the reference 25°C	
	Standard	<0.5 ppm
	Option OCXO-C08	<0.005 ppm
Phase Noise (at 10 kHz offset)	10 kHz, $f_c = 500$ MHz <-100 dBc/Hz, <-102 dBc/Hz (typical)	
Resolution Bandwidth (-3 dB)	1 Hz to 3 MHz, in 1-3-10 sequence	
Resolution Bandwidth (-6 dB) (Option RSA3000-EMC)	200 Hz, 9 kHz, 120 kHz, 1 MHz	
Displayed Average Noise Level (DANL)	preamp on, attenuation = 0 dB, sample detector, trace averages $\geq 50$ , tracking generator off, normalized to 1 Hz, 20°C to 30°C, input impedance = 50 $\Omega$ . <-158 dBm, <-161 dBm (typical)	
Level Measurement Uncertainty	1.0 dB (nominal)	
TG Frequency Range (only available for the model with the TG)	100 kHz to 1.5 GHz	100 kHz to 3 GHz
TG Output Level Range (only available for the model with the TG)	-40 dBm to 0 dBm	-40 dBm to 0 dBm
Real-time Analysis Bandwidth	10 MHz (real-time analysis bandwidth not supported)	
Full-scale Accuracy	maximum span; default Kaiser Window	
Min. signal duration for 100% POI at the full-scale accuracy	9.3 $\mu$ s	
Window Type	Hanning, Blackman-Harris, Rectangular, Flattop, Kaiser, Gaussian	
FFT Rate	146,484/s (nominal)	
SFDR	mixer level = -30 dBm <-50 dBc/Hz (typical)	
Trigger Source	Free Run, External, Power, FMT	

## Ordering Information

	Description	Order No.
Model	Real-time Spectrum Analyzer, 9 kHz to 1.5 GHz	RSA3015E
	Real-time Spectrum Analyzer, 9 kHz to 3 GHz	RSA3030E
	Real-time Spectrum Analyzer, 9 kHz to 1.5 GHz (with tracking generator, factory installed)	RSA3015E-TG
	Real-time Spectrum Analyzer, 9 kHz to 3 GHz (with tracking generator, factory installed)	RSA3030E-TG
Standard Accessories	Power Cord	-
Option	EMI Measurement Application (includes RSA3000E-EMC)	RSA3000E-EMI
	Preamplifier (PA)	RSA3000E-PA
	Highly Stable Clock(Need to be installed before leaving the factory)	OCXO-C08
	Advanced Measurement Kit	RSA3000E-AMK
	EMC Filter and Quasi-peak Detector Kit	RSA3000E-EMC
	Spectrum Analyzer PC Software	Ultra Spectrum
	VSWR Measurement Kit	RSA3000E-VSWR
ASK/FSK Demodulation Software	RSA3000E-ASK/FSK	

For optional options and accessories of other RF instruments, please refer to "Options and Accessories Guide" of the specified RF instrument.

# DSA800/E Series Spectrum Analyzers



DSA800 and DSA800E series spectrum analyzer are the high performance economic level spectrum analyzers which have compact size and light weight. The digital IF technology guarantees their reliability and performance. The measurement

frequency range is up to 7.5GHz. In order to satisfy different customers' applications, there're lots of standard or optional function and accessories, for example, the pre-amplifier, Advanced Measurement kit, TG models, the VB series bridges and VSWR measurement function, ASK/FSK demodulation, EMI pre-compliance test software and so on.

- Frequency range from 9KHz to 7.5GHz
- Min. RBW 10 Hz
- Min. Displayed Average Noise Level -161 dBm
- Min. Phase Noise < -98 dBc/Hz @ 10 kHz Offset
- EMI Pre-compliance test
- VSWR Measurement
- Signal seamless capture mode (DSA815)
- Powerful DSA PC software

Distinguish the two nearby signals clearly with the 10 Hz RBW

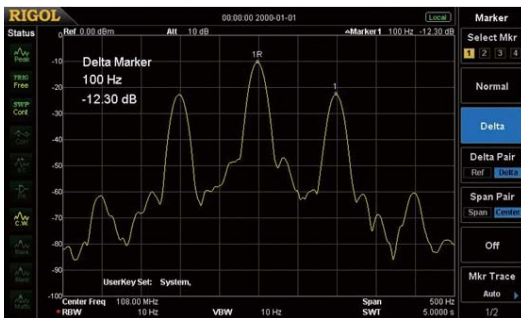

EMI kit (EMI filter & Quasi-peak & Pass/Fail)

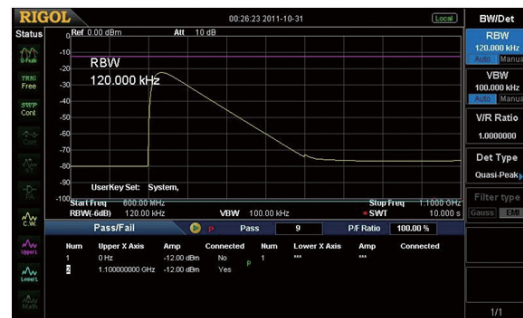

Phase noise < -98 dBc/Hz @ 10 kHz offset (DSA832/DSA875)

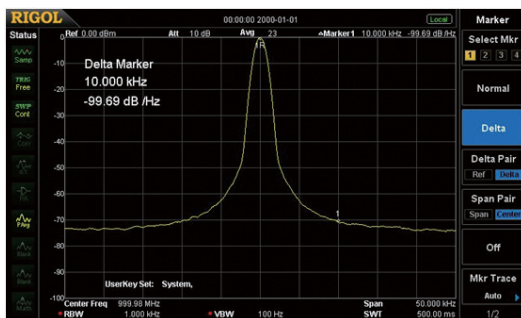

VSWR measurement

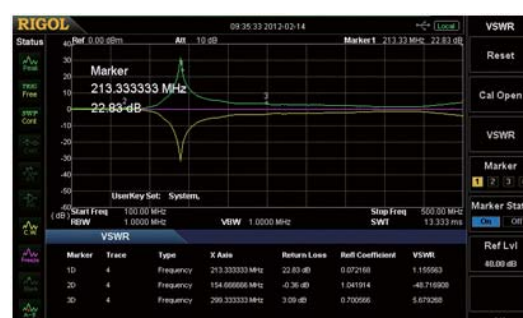

Measure lower level signal with the preamplifier turn on

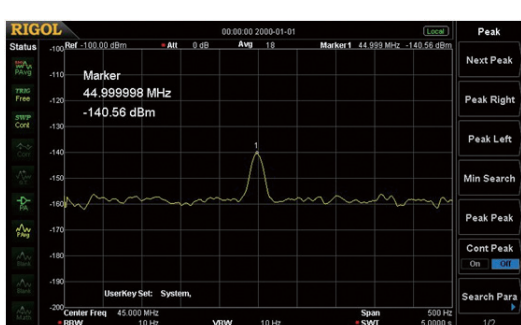

Powerful DSA PC software

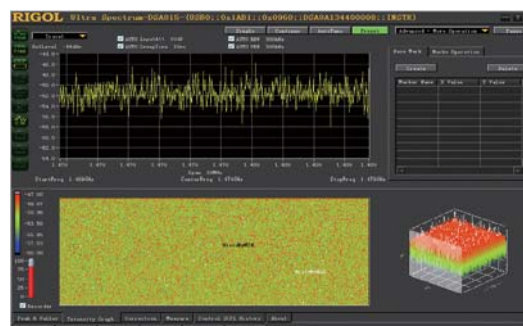

## Key Specifications

	DSA815/DSA815-TG	DSA832E/DSA832E-TG	DSA832/DSA832-TG	DSA875/DSA875-TG
Frequency range	9 kHz to 1.5 GHz	9 kHz to 3.2 GHz	9 kHz to 3.2 GHz	9 kHz to 7.5 GHz
Frequency resolution	1 Hz			
Aging rate	<2 ppm/year	<2 ppm/year	<1 ppm/year	
SSB Phase Noise(fc=1GHz)	<-80 dBc/Hz@10kHz offset	<-90 dBc/Hz @ 10kHz offset <-98 dBc/Hz @ 10kHz offset (typ.)	<-98 dBc/Hz@10kHz offset	
	<-100 dBc/Hz @ 100kHz offset (typ.)	<-100 dBc/Hz@100kHz offset (typ.)	<-100 dBc/Hz@100kHz offset (typ.)	
Resolution bandwidth (-3 dB)	10 Hz to 1 MHz, in 1-3-10 sequence			
Video bandwidth (-3 dB)	1 Hz to 3 MHz, in 1-3-10 sequence			
Resolution bandwidth (-6 dB)	200 Hz, 9 kHz, 120 kHz (EMI-DSA800 option)			
Displayed Average Noise Level (DANL)	PA on , attenuation = 0 dB, RBW = VBW = 100 Hz, sample detector, trace average ≥ 50, tracking generator off, normalized to 1Hz, 20°C to 30°C , input impedance = 50 Ω			
100 kHz to 1 MHz	<-130 dBm, <-150 dBm (typ.)	<-152 dBm (typ.)	<-152 dBm (typ.)	<-152 dBm (typ.)
1 MHz to 5 MHz	<-150 dBm + 6 × (f/1 GHz) dB, <-155 dBm (typ.)	<-150 dBm, <-155 dBm (typ.)	<-152 dBm, <-155 dBm (typ.)	<-152 dBm, <-155 dBm (typ.)
5 MHz to 1.5 GHz			<-157 dBm, <-161 dBm (typ.)	<-157 dBm, <-161 dBm (typ.)
1.5 GHz to 3.2 GHz		<-155 dBm, <-161 dBm (typ.)		
3.2 GHz to 6 GHz				<-153 dBm, <-157 dBm (typ.)
6 GHz to 7.5 GHz				<-148 dBm, <-152 dBm (typ.)
Trace detectors	normal, positive-peak, negative-peak, sample, RMS, voltage average, quasi-peak (with EMI-DSA800 option)			
Trace functions	clear write, max hold, min hold, average, view, blank			
Units of level axis	dBm, dBmV, dBμV, nV, μV, mV, V, nW, μW, mW, W			
Level measurement uncertainty	<1.5 dB (nom.)	<1.0 dB (nom.)	<0.8 dB (nom.)	<0.8 dB (nom.)
TG Frequency range (-TG model)	100 kHz to 1.5 GHz	100 kHz to 3.2 GHz	100 kHz to 3.2 GHz	100 kHz to 7.5 GHz
TG Output level range (-TG model)	-20 dBm to 0 dBm	-40 dBm to 0 dBm		
TG Output level resolution (-TG model)	1 dB			
SSC Measurement bandwidth <sup>[1]</sup>	1.5 MHz			
ASK/FSK Demodulation Analysis (PC option)		Support S1220 ASK-FSK Demodulation Analysis		
Interfaces	LAN(LXI), USB, USB-GPIB(Optional)			

Note[1]: Unavailable for DSA832E/DSA832/DSA875

## Ordering Information

	Description	Order Number
Models	spectrum analyzer, 9 kHz to 1.5 GHz	DSA815
	spectrum analyzer, 9 kHz to 3.2 GHz	DSA832
	spectrum analyzer, 9 kHz to 7.5 GHz	DSA875
	spectrum analyzer, 9 kHz to 3.2 GHz	DSA832E
	spectrum analyzer, 9 kHz to 1.5 GHz (with tracking generator, factory installed)	DSA815-TG
	spectrum analyzer, 9 kHz to 3.2 GHz (with tracking generator, factory installed)	DSA832-TG
	spectrum analyzer, 9 kHz to 7.5 GHz (with tracking generator, factory installed)	DSA875-TG
Standard accessories	power cable	--
Options	EMI filter & quasi-peak detector	EMI-DSA800
	advanced measurement kit	AMK-DSA800
	VSWR measurement kit	VSWR-DSA800
	DSA PC software	Ultra Spectrum
	signal seamless capture (only for DSA815 and DSA700)	SSC-DSA
	EMI Pre-compliance test software	S1210 EMI Pre-compliance Software
ASK-FSK Demodulation Analysis (only for DSA832/DSA875/DSA832E)	S1220 ASK-FSK Demodulation Analysis Software	

For other optional accessories, please refers to the "RF Accessories Selection Guide".

# DSA700 Series Spectrum Analyzers



DSA700 series spectrum analyzer are the high performance economic level spectrum analyzers which have compact size and light weight. The digital IF technology guarantees their reliability and performance. The measurement frequency

range is from 100KHz to 1GHz. In order to satisfy different customers' applications, there're lots of standard or optional function and accessories, for example, the pre-amplifier, Advanced Measurement kit, signal seamless capture mode, EMI pre-compliance test software and so on.

- Frequency range from 100KHz to 1GHz
- Min. RBW 100 Hz
- Min. Displayed Average Noise Level -130 dBm
- Min. Phase Noise < -80 dBc/Hz @ 10 kHz Offset
- EMI Pre-compliance test
- Signal seamless capture mode
- Powerful DSA PC software

Distinguish the two nearby signals clearly with the 100 Hz RBW

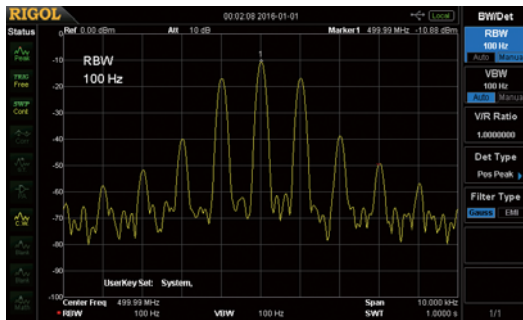

Compare the spectrums with different color trace

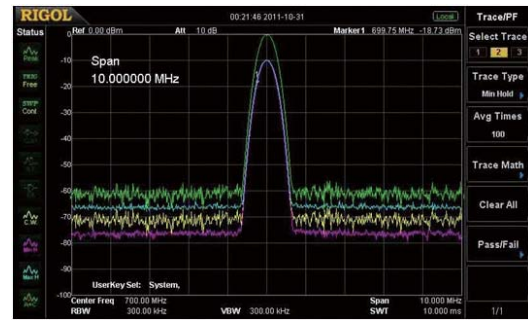

Phase noise < -80 dBc/Hz @ 10 kHz offset

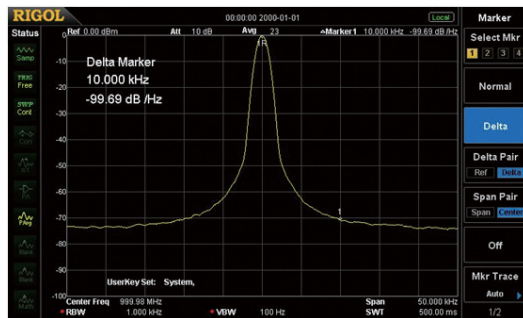

EMI kit (EMI filter & Quasi-peak & Pass/Fail)

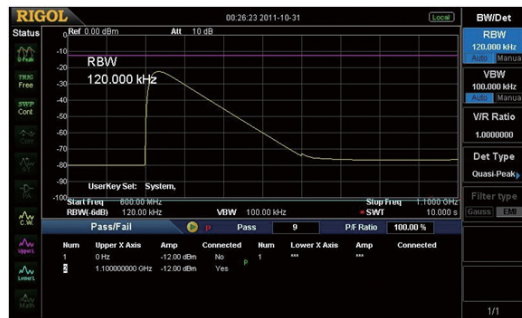

The GUI to control the RF demo kit (Transmitter) directly

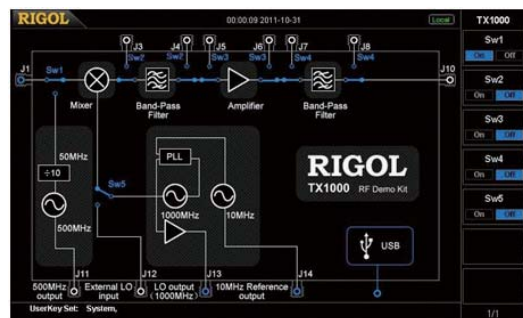

Zero span to demodulate the AM signal

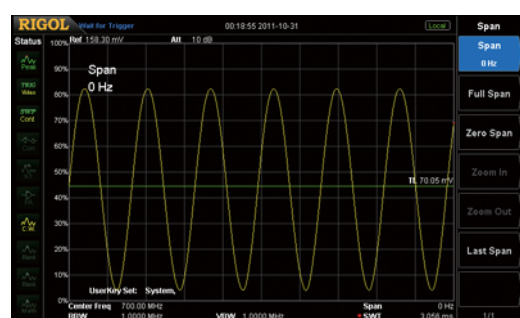

### Seamless capture RKE FSK signal

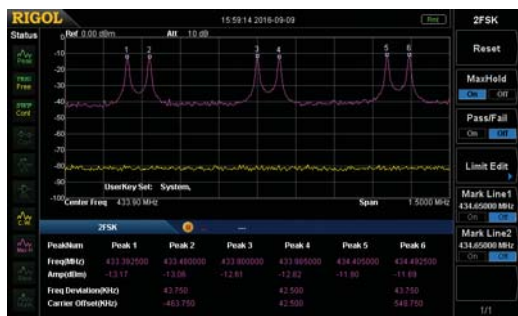

### Seamless capture RKE ASK signal

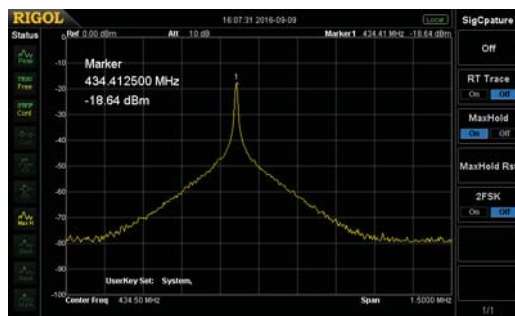

## Key Specifications

	DSA705	DSA710
Frequency range	100 kHz to 500 MHz	100 kHz to 1 GHz
Frequency resolution	1 Hz	
Aging rate	<2 ppm/year	
SSB Phase Noise (fc=1GHz)	<-80dBc/Hz@10kHz offset	
Resolution bandwidth (-3dB)	100Hz ~ 1MHz; 1-3-10 step	
Resolution bandwidth (-6dB)	200Hz, 9kHz, 120KHz (EMI-DSA800 option)	
Video bandwidth (-3dB)	1 Hz ~ 3MHz, 1-3-10 step	
Max. DC voltage	50 V	
Max. CW RF power	attenuation = 30 dB, +20 dBm (100 mW)	
Max. damage level	+30 dBm (1 W)	
Displayed Average Noise Level (DANL)	PA ON, RBW=VBW=100Hz, sample detector, trace average ≥ 50	
100 kHz to 1 MHz	<-110 dBm, <-130 dBm (typical)	
1 MHz to 500 MHz	<-120 dBm, <-130 dBm (typical)	
500 MHz to 1 GHz	<-120 dBm, <-130 dBm (typical)	
Trace detectors	normal, positive-peak, negative-peak, sample, RMS, voltage average,quasi-peak (with EMI-DSA800 option)	
Trace functions	clear write, max hold, min hold, average, view, blank	
Units of level axis	dBm, dBmV, dBμV, nV, μV, mV, V, nW, μW, mW, W	
Level measurement uncertainty	<1.5 dB (nom.)	
SSC Measurement bandwidth	1.5 MHz	
Interface	LAN (LXI), USB, USB-GPIB (option)	

## Ordering Information

	Description	Order Number
Models	spectrum analyzer, 100 kHz to 500 MHz (with preamplifier)	DSA705
	spectrum analyzer, 100 kHz to 1 GHz (with preamplifier)	DSA710
Standard accessories	power cable	--
Options	EMI filter & quasi-peak detector	EMI-DSA800
	advanced measurement kit	AMK-DSA800
	DSA PC software	Ultra Spectrum
	Signal seamless capture	SSC-DSA

For other optional accessories, please refers to the "RF accessories selection table".



# EMI Test System<sup>[1]</sup> (S1210)

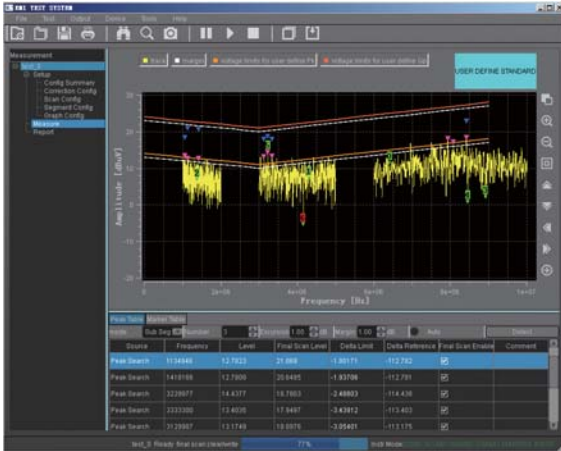

EMI Test System is a PC application software developed by RIGOL for RSA5000, RSA3000/E, DSA800, DSA800E and DSA700 series with the EMI-DSA800 option to do the EMI Pre-compliance tests.

You can perform conduction and radiation tests using S1210 EMI Pre-compliance Software and RIGOL RSA/DSA series spectrum analyzer. You can measure the interference voltage on the power cable using the linear impedance

stability network (LISN) and perform amplitude correction on the results by loading the correction factor (preamplifier, attenuator, antenna, cable, or correction array) automatically in the radiation test.

This software also provides various functions to facilitate your measurements. You can set various parameters (such as the frequency range, resolution bandwidth, and scan time) via the scan table. After performing a scan, the results can be displayed in log or linear format. You can search for signal peak value and view the results displayed in the peak table. Besides, you can mark and delete the undesired signal, as well as easily recognize signals that do not pass the standard limit line. The software also supports the marker table. In the marker table, you can double click the table to add a marker to mark any frequency point that interests you.

- Provide amplitude correction function.
- Segment scanning and editing for the table to accelerate the measurement speed
- The limit line function can be used to quickly judge the measurement results.
- Provide fast pre-scan and final scan modes.
- Provide peak search function.
- Importing and exporting the peak table
- Frequency axis supports the scale display in linear or log format
- Amplitude axis supports multiple amplitude units
- Provide report generation function

## Recommended Configuration

	Description	Order Number
Spectrum Analyzer	RSA5000/3000/3000E, DSA800/800E/700 series spectrum analyzer	Refer to RSA/DSA model numbers
	EMI filter & quasi-peak detector of RSA5000 series spectrum analyzer	RSA5000-EMC
	EMI filter & quasi-peak detector of RSA3000 series spectrum analyzer	RSA3000-EMC
	EMI filter & quasi-peak detector of RSA3000E series spectrum analyzer	RSA3000E-EMC
	EMI filter & quasi-peak detector of DSA800/800E/700 series spectrum analyzer	EMI-DSA800
EMI Software	EMI Test System Pre-Compliance Test software	S1210
Test Accessories	Near field probe (for near field radiated EMI testing)	NFP-3
	Line Impedance Stabilization Network (LISN) (for conducted EMI testing)	3rd Party
	Antenna (for far field radiated EMI testing)	3rd Party

## NFP-3 Near Field Probes

NFP-3 is used with RIGOL RSA/DSA series spectrum analyzer for the EMI tests of electronic products. It can be used to test the magnetic field strength and magnetic field coupling channels on the surface of the electronic components as well as the magnetic field environment near the electronic module so as to quickly locate the interference source. NFP-3 includes four models (NFP-3-P1, NFP-3-P2, NFP-3-P3 and NFP-3-P4).

### Measurement Connections

The connection mode of NFP-3 and spectrum analyzer is as shown in the figure below.

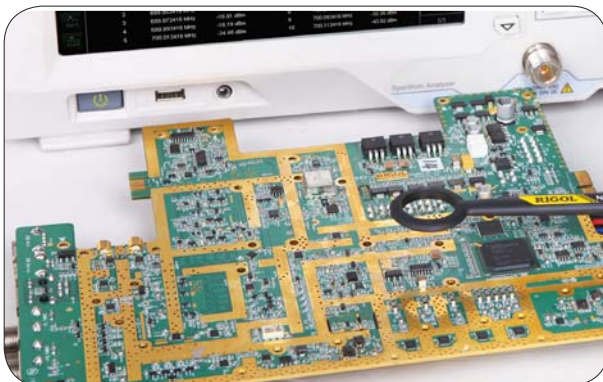

[1] Alternative selection: RSA5000-EMI & RSA3000-EMI

### Connect the spectrum analyzer

Connect the SMB (M) terminal of NFP-3 and the BNC (F) terminal of the N-BNC adaptor respectively via the BNC-SMB RF cable; connect the N (M) terminal of the N-BNC adaptor to the RF input terminal of the spectrum analyzer.

### Connect the device under test

NFP-3 is used to perform short-distance noncontact measurement on the device under test. Pay attention to the direction of the probe during measuring.

### Typical Applications

Locate the EMI radiation interference source. Determine the frequency and relative strength of the spectral component of the interference source.

## Specification

Frequency	
Frequency Range	30 MHz to 3 GHz
Terminal Type	
Terminal Type	SMB (M)
Adaptor	N (M)-BNC (F)
RF Cable	BNC (M)-SMB (F), 1000 mm
Terminal and Adaptor Impedance	50 $\Omega$

## Common RF Accessories



DSA Utility Kit



RF CATV Kit



30dB High Power Attenuator



RF Adaptor Kit



RF Attenuator Kit



VSWR Bridge



CK106A



CK106E



RF Cable

# RF Accessories Selection Guide

Options	Descriptions	RSA5065/-TG/N	RSA5032/-TG/N	RSA3030/-TG/N	RSA3045/-TG/N	RSA3015N	RSA3030E/-TG	RSA3015E/-TG	DSA875/-TG	DSA832/-TG	DSA832E/-TG	DSA815/-TG	DSA710	DSA705
RSA5000-AMK	Advanced Measurement Kit. Include:T-Power,ACP(Adjacent Channel Power),ChanPwr(Channel Power),OBW(Occupied Bandwidth),EBW(Emission Bandwidth),C/N Ratio,HarmoDist(Harmonic Distortion),TOI(Third Order Inter modulation)	○	○											
RSA3000-AMK	Advanced Measurement Kit. Include:T-Power,ACP(Adjacent Channel Power),ChanPwr(Channel Power),OBW(Occupied Bandwidth),EBW(Emission Bandwidth),C/N Ratio,HarmoDist(Harmonic Distortion),TOI(Third Order Inter modulation)			○	○	○								
RSA3000E-AMK	Advanced Measurement Kit. Include: T-Power, ACP (Adjacent Channel Power), ChanPwr (Channel Power), OBW (Occupied Bandwidth), EBW (Emission Bandwidth), C/N Ratio, HarmoDist (Harmonic Distortion), TOI (Third Order Inter modulation), and Pass/Fail test						○	○						
AMK-DSA800	Advanced Measurement Kit. Include:T-Power,ACP(Adjacent Channel Power),ChanPwr(Channel Power),OBW(Occupied Bandwidth),EBW(Emission Bandwidth),C/N Ratio,HarmoDist(Harmonic Distortion),TOI(Third Order Inter modulation)								○	○	○	○	○	○
RSA5000-VSA	Vector Signal Analysis Measurement Application	○	○											
RSA5000-EMC	EMI filter & quasi-peak detector	●	●											
RSA3000-EMC	EMI filter & quasi-peak detector			○	○	○								
RSA3000E-EMC	EMI filter & quasi-peak detector						○	○						
RSA5000-EMI	EMI Measurement Application	○	○											
RSA3000-EMI	EMI Measurement Application(including RSA3000-EMC)			○	○	○								
RSA3000E-EMI	EMI Measurement Application (including RSA3000E-EMC)						○	○						
EMI-DSA800	EMI filter & quasi-peak detector								○	○	○	○	○	○
VSWR-RSA5000	VSWR Measurement Kit.Measurement results include return loss,reflection coefficient and VSWR.(Work with VSWR bridge)	●	●											
VSWR-RSA3000	VSWR Measurement Kit.Measurement results include return loss,reflection coefficient and VSWR.(Work with VSWR bridge)			●	●	●	●	●						
VSWR-DSA800	VSWR Measurement Kit.Measurement results include return loss,reflection coefficient and VSWR.(Work with VSWR bridge)								○	○	○	○		
S1210	EMI test PC software for EMI Pre-Compliance testing	○	○	○	○	○	○	○	○	○	○	○	○	○
Ultra Spectrum	DSA PC software	○	○	○	○	○	○	○	○	○	○	○	○	○
S1220	ASK/FSK Demodulation function								○	○	○			
SSC-DSA	Signal Seamless Capture function	●	●	●	●	●	●	●				○	○	○
RSA5000-PA	Preamplifier(for RSA5000 only)	○	○											
RSA3000-PA	Preamplifier(for RSA3000 only)			○	○	○								
RSA3000E-PA	Preamplifier (available for RSA3000E)						○	○						
PA-DSA800	Preamplifier								●	●	●	●	●	●
RSA5000-B40	Real-time Analysis Bandwidth 40 MHz	○	○											
RSA3000-B25	Real-time Analysis Bandwidth 25 MHz (not available for the E type model)			○	○	○								
RSA3000-B40	Real-time Analysis Bandwidth 40 MHz (not available for the E type model)						○	○						
OCXO-C08	Highly Stable Clock(Need to be installed before leaving the factory)	○	○	○	○	○	○	○						
NFP-3	Near Field Probe,30MHz~3GHz,4pcs	○	○	○	○	○	○	○	○	○	○	○	○	○
DSA Utility Kit	Include: N-SMA Cable, BNC-BNC Cable, N-BNC Adapter, N-SMA Adapter, 75Ω-50ΩAdapter, Antenna2(900MHz/1.8GHz),Antenna2(2.4GHz)	○	○	○	○	○	○	○	○	○	○	○	○	○
RF Adaptor Kit	Include:N(F)-N(F) Adaptor(1pcs),N(M)-N(M) Adaptor(1pcs),N(M)-SMA(F) Adaptor(2pcs),N(M)-BNC(F) Adaptor(2pcs),SMA(F)-SMA(F) Adaptor(1pcs),SMA(M)-SMA(M) Adaptor(1pcs),BNC Ttype Adaptor(1pcs),50Ω SMA Load(1pcs),50Ω Impedance Adaptor(1pcs)	○	○	○	○	○	○	○	○	○	○	○	○	○
RF CATV Kit	Include:50Ω to 75Ω Adaptor (2 pcs)	○	○	○	○	○	○	○	○	○	○	○	○	○
RF Attenuator Kit	Include:6dB Attenuator (1 pcs),10dB Attenuator (2 pcs)	○	○	○	○	○	○	○	○	○	○	○	○	○
ATT03301H	30dB High Power Attenuator,Max.Power 100 W	○	○	○	○	○	○	○	○	○	○	○	○	○
CB-NM-NM-75-L-12G	N (M) - N (M) RFCable,upto 12.4 GHz	○	○	○	○	○	○	○	○	○	○	○	○	○
CB-NM-SMAM-75-L-12G	N (M) - SMA (M) RF Cable,up to 12.4 GHz	○	○	○	○	○	○	○	○	○	○	○	○	○
TX1000	RF Demo Kit (Transmitter)								○	○	○	○	○	○
VB1032 <sup>[1]</sup>	only available for the model with the TG VSWR Bridge (1 MHz to 3.2 GHz)	○	○	○	○	○	○	○	○	○	○	○		
VB1040 <sup>[1]</sup>	only available for the model with the TG VSWR Bridge (800 MHz to 4 GHz)	○	○	○	○	○	○	○	○	○	○	○		
VB1080 <sup>[1]</sup>	only available for the model with the TG VSWR Bridge (2 GHz to 8 GHz)	○	○	○	○	○	○	○	○	○	○	○		
RM6041	Rack Mount Kit (for RSA series)	○	○	○	○	○	○	○						
RM-DSA800	Rack Mount Kit (for DSA800 and DSA700 series)								○	○	○	○	○	○
USB-GPIB	USB to GPIB Interface Converter for Instrument								○	○	○	○	○	○
BAG-G1	Soft Carrying Bag (for DSA800 series only)								○	○	○	○	○	○
CK106A&CK106E	High-performance Network Analysis Calibration Kit (only available for -N model)	○	○	○	○	○								

● Standard function ○ Options [1] Option gift:VSWR-DSA800

# RF Signal Generators



RIGOL RF signal generators adopt an innovative design, breaking through the cost bottleneck of traditional products, providing users with unprecedented cost-effective products. DSG series signal generators can provide highly pure RF signals, and the typical value of phase noise can be as low as -116 dBc/Hz. The application of digital ALC circuit enables accurate control of the amplitude of output RF signals, with power accuracy up to 0.5 dB. In addition to the conventional AM/FM/ΦM modulation, the RF signal source can also provide pulse modulation and pulse train functions to meet the demand of all kinds of communication and research. DSG3000-IQ/DSG800A model also offers a variety of I/Q

modulations, supporting internal or external modulation and providing IF signal output. The convenient operation and abundant functions make DSG series RF signal generators become the ideal instrument for the development and design of wireless communication, Internet of things (IoT) and consumer electronic products, and provide a cost-effective test scheme for the production and testing of RF components. The economical DSG800 series sets a new benchmark for RF testing instruments, making it possible for each engineer of college teaching experiments and basic RF development to be equipped with one such instrument.

	Frequency Range							Level Range	Accuracy	Clock Stability	Phase Noise	Std. Modulations	Pulse Train Generator	I/Q
	1.5 GHz	2.1 GHz	3 GHz	3.6 GHz	6 GHz	6.5 GHz	13.6 GHz							
DSG815	•							-110dBm- +13dBm	≤ 0.5dB (Typ.)	<2ppm <5ppb (Opt. OCXO-B08)	-112dBc/Hz (Typ.)	AM/FM/ ΦM	DSG800-PUM DSG800-PUG (Pulse Modulation + Pulse Train )	-
DSG830			•				-							
DSG821		•					Std.							
DSG821A		•					-							
DSG836				•			Std.							
DSG836A				•			-							
DSG3065B						•	-110dBm- +27dBm	≤ 0.5dB (Typ.)	<1ppm <5ppb (Opt. OCXO-B08)	-116dBc/Hz (Typ.)	AM/FM/ ΦM	DSG3000B-PUG	-	
DSG3065B-IQ					•	Std.								
DSG3136B						•							-	
DSG3136B-IQ						•							Std.	

# DSG3000B Series RF Signal Generator



The DSG3000B series is a high-performance RF signal generator. It provides comprehensive modulation solutions: AM/FM/ΦM analog modulation; pulse modulation with user-defined pulse train; and I/Q modulation. All the modulations support internal and external modulation sources. In addition, to meet the demands of production environments, the DSG3000B series has undergone a strict verification through the experiments in its design and production stages to ensure its high stability and reliability. The DSG3000B series also features a clear user interface, compact size and light weight. It is easy to operate and can output stable, precise and pure signals. It is an ideal tool in

various fields such as communication, computers, instrumentation, R&D, education, production and maintenance.

- Highest frequency: 6.5 GHz/13.6 GHz
- Amplitude accuracy: <0.5 dB (typical)
- Output amplitude range: -130 dBm to +27 dBm (settable)
- High signal purity, phase noise: <-116 dBc/Hz@20 kHz (typical)
- Standard 1 ppm internal clock; optional 5 ppb high stable clock
- Standard AM/FM/ΦM analog modulation
- Support pulse modulation; on/off ratio up to 70 dB;
- user-defined pulse train generator
- I/Q modulation and I/Q baseband output
- All modulations support internal and external modulation modes
- Standard 2U height design to save rack space;
- rack mount kit is available
- Support USB/LAN/GPIB remote control; SCPI command set
- Wear-free electronic attenuator design

## Excellent High-Power Signal Generator

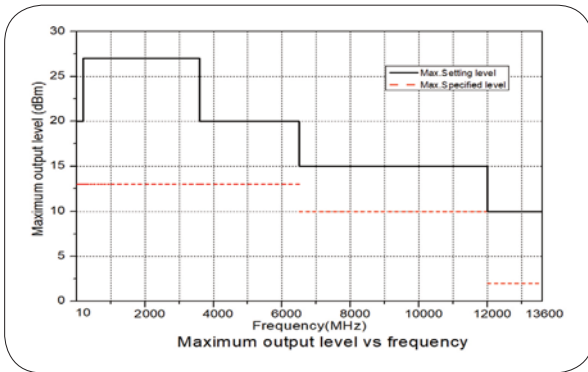

## Excellent Phase Noise

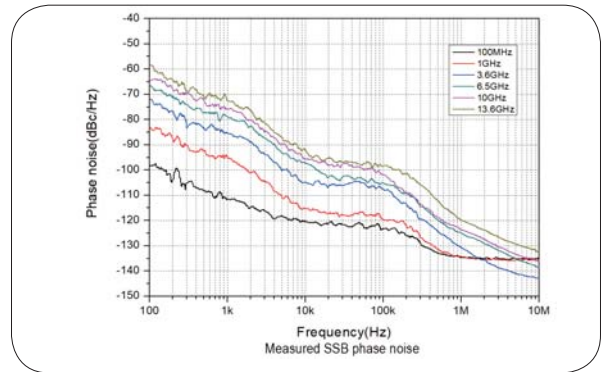

## Support Internal and External IQ Modulation

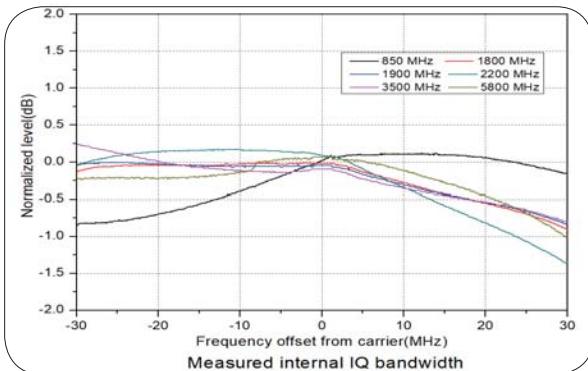

## Support Pulse Modulation; On/Off Ratio Up to 70 dB

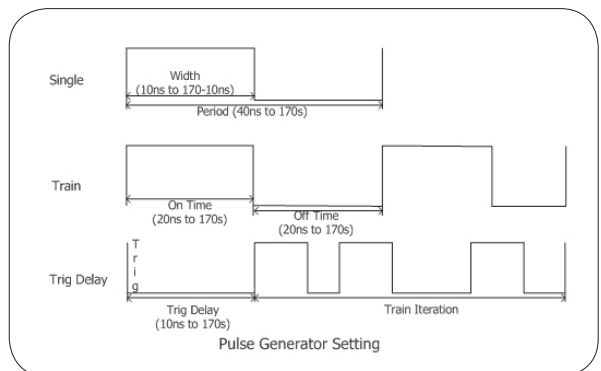

## Combined Modulation

Simultaneous Modulation						
	AM	FM	ΦM	Pulse mod.	I/Q mod.	
AM	—	○	○	△	×	
FM	○	—	×	○	○	
ΦM	○	×	—	○	○	
Pulse mod.	△	○	○	—	○	
I/Q mod.	×	○	○	○	—	

Note: ○ : compatible; × : not compatible; △ : compatible, but the AM performance will be undermined when pulse modulation is enabled.

## Key Specifications

Model		DSG3065B	DSG3065B-IQ	DSG3136B	DSG3136B-IQ
Frequency Range		9 kHz to 6.5 GHz	9 kHz to 6.5 GHz (IQ: 50 MHz to 6.5 GHz)	9 kHz to 13.6 GHz	9 kHz to 13.6 GHz (IQ: 50 MHz to 6.5 GHz)
Amplitude Range		-110 dBm to +13 dBm			
Amplitude Setting Range		-130 dBm to +27 dBm			
Amplitude Accuracy		< 0.9 dB (<0.5 dB, typical)			
Clock Reference Stability		< 1 ppm, <5 ppb (with the high stable OCXO reference clock OCXO-B08)			
Spectral Purity	SSB phase noise	CW mode, carrier offset = 20 kHz, 1 Hz measurement bandwidth f=1 GHz <-110 dBc/Hz, <-116 dBc/Hz (typical) f=6.5 GHz <-98 dBc/Hz, <-102 dBc/Hz (typical) f=13.6 GHz <-92 dBc/Hz, <-96 dBc/Hz (typical)			
	Harmonic	CW mode < -30 dBc (2 MHz < f ≤ 6.5GHz, level ≤ +13 dBm; 6.5 GHz < f ≤ 12 GHz, level ≤ +10 dBm; 12 GHz < f ≤ 13.6 GHz, level ≤ 2 dBm)			
	Non-harmonic	CW mode, level > -10 dBm, carrier offset > 10 kHz 100 kHz ≤ f ≤ 1.5 GHz < -60 dBc, < -70 dBc (typical) 1.5 GHz ≤ f ≤ 3.6 GHz < -54 dBc, < -64 dBc (typical) 3.6 GHz ≤ f ≤ 6.5 GHz < -48 dBc, < -58 dBc (typical) 6.5 GHz ≤ f ≤ 13.6 GHz < -42 dBc, < -52 dBc (typical)			
Sweep	Sweep Mode	Step/List sweep, single/continuous			
	Sweep Points	2 to 65,535 (step sweep); 1 to 6,001 (list sweep)			
Modulation Type		AM, FM, ØM, pulse modulation, and I/Q modulation <sup>[1]</sup>			
AM	Modulation Depth	0% to 100%			
	Setting Uncertainty	< setting value × 4% + 1%			
	Modulation Frequency Response	<3 dB (10 Hz to 100kHz, m<80%)			
FM	Max. Deviation	N <sup>[2]</sup> × 1 MHz			
	Setting Uncertainty	< setting value × 2% + 20 Hz			
	Modulation Frequency Response	<3 dB (10 Hz – 100 kHz)			
ØM	Max. Deviation	N <sup>[2]</sup> × 5 rad			
	Setting Uncertainty	< setting value × 1% + 0.1 rad			
	Modulation Frequency Response	<3 dB (10 Hz – 100 kHz)			
Pulse Modulation	On/off Ratio	>70 dB (100 kHz ≤ f <3.6 GHz)			
	Rise/Fall Time	< 50 ns (typical)			
	Pulse Mode	Single pulse, pulse train (option DSG3000B-PUG)			
I/Q Modulation (Only Available for DSG3065B-IQ and DSG3136B-IQ)	Bandwidth (RF)	External modulation: baseband (I or Q): ≤ 60 MHz (nom.); RF (I + Q): ≤ 120 MHz Internal modulation: baseband (I or Q): ≤ 30 sMHz (nom.); RF (I + Q): ≤ 60MHz			
	EVM	≤ 2%rms (typical)			
General Specifications	Interface	Standard: USB and LAN			
		Front panel: RF output, internal modulation generator (LF) output, and external modulation input (EXT MOD INPUT),			
		Rear panel: external trigger input, signal valid output, pulse input/output, and 10 MHz In/Out			

Note[1]: Frequency range of AM, PM, ØM, and pulse modulation ≤3.6 GHz

Note[2]: f < 227.5 MHz, N=0.25; 227.5 MHz ≤ f < 455 MHz, N=0.125; 455 MHz ≤ f < 910 MHz, N=0.25; 910 MHz ≤ f < 1820 MHz, N=0.5;

1820 MHz ≤ f ≤ 3600 MHz, N=1; 3600 MHz < f ≤ 6500 MHz, N =2; 6500 MHz < f ≤ 13600 MHz, N = 4

## Ordering Information

	Description	Order No.
Model	RF Signal Generator, 9 kHz to 6.5 GHz	DSG3065B
	RF Signal Generator, 9 kHz to 6.5 GHz, I/Q Modulation (Std.)	DSG3065B-IQ
	RF Signal Generator, 9 kHz to 13.6GHz	DSG3136B
	RF Signal Generator, 9 kHz to 13.6GHz, I/Q Modulation (Std.)	DSG3136B-IQ
Standard Accessories	Power Cord	-
	Pulse Modulation, Pulse Generator, and Pulse Train Generator	DSG3000B-PUG
Optional Accessories	High Stable OCXO Reference Clock (Need to be installed before leaving the factory)	OCXO-B08
	Rack Mount Kit	RM-DSG3000
	Include: N(F)-N(F) adaptor (1pcs), N(M)-N(M) adaptor (1pcs), N(M)-SMA(F) adaptor (2pcs), N(M)-BNC(F) adaptor (2pcs), SMA(F)-SMA(F) adaptor (1pcs), SMA(M)-SMA(M) adaptor (1pcs), BNC T type adaptor (1pcs), 50 Ω SMA load (1pcs), 50 Ω BNC impedance adaptor (1pcs)	RF Adaptor Kit
	Include: 50 Ω to 75 Ω adaptor (2pcs)	RF CATV Kit
	Include: 6 dB attenuator (1pcs), 10 dB attenuator (2pcs)	RF Attenuator Kit
	N(M)-N(M) RF Cable	CB-NM-NM-75-L-12G
	N Male-SMA Male RF Cable	CB-NM-SMAM-75-L-12G
	USB-GPIB Interface Converter	USB-GPIB

# DSG800 Series RF Signal Generators



DSG800 establishes a new standard of economical RF signal generator by the unprecedented cost-effective advantage. Combining with DSA800 economical spectrum analyzer, the product pair provides a screaming solution for RF test and measurement application.

DSG800 series signal generator includes 6 models: DSG815, DSG830, DSG821, DSG836, DSG821A, and DSG836A. Its frequency ranges from 9 kHz to 1.5 GHz/2.1 GHz/3 GHz/3.6 GHz, with the typical phase noise -112 dBc/Hz, typical amplitude accuracy 0.5 dB. It provides the standard AM/FM/ØM analog modulation function. The pulse modulation and pulse train functions are also available as options. It's compact in size and easy to carry, suitable for outdoor use.

- Up to -112 dBc/Hz (typical) phase noise
- Up to +20 dBm (typical) maximum output power
- Special digital ALC circuit ensuring its stability and reliability
- Flexible frequency and amplitude sweep functions
- Open vector modulation function (for A type model)
- Powerful pulse modulation function
- Prominent portability; Simple and easy to operate

Measured SSB phase noise

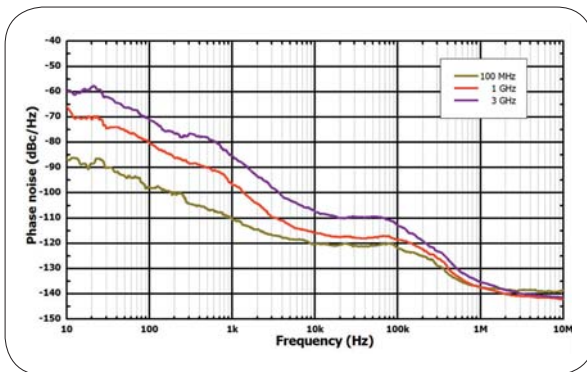

Measured level repeatability @ 1 GHz, 0 dBm

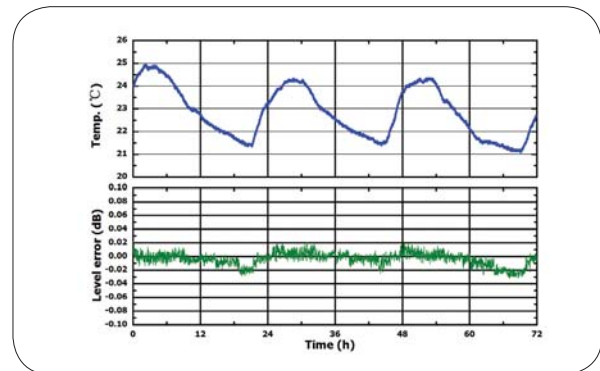

Measured maximum level vs. frequency

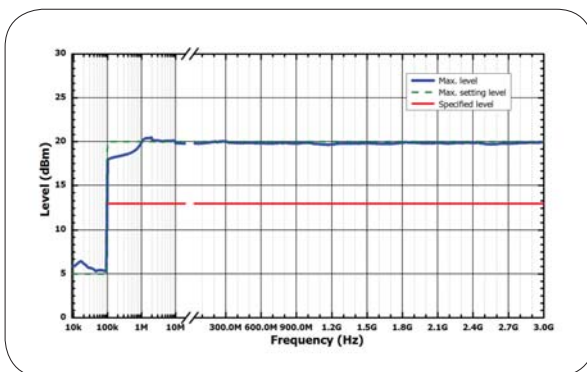

Powerful pulse modulation and pulse train generator

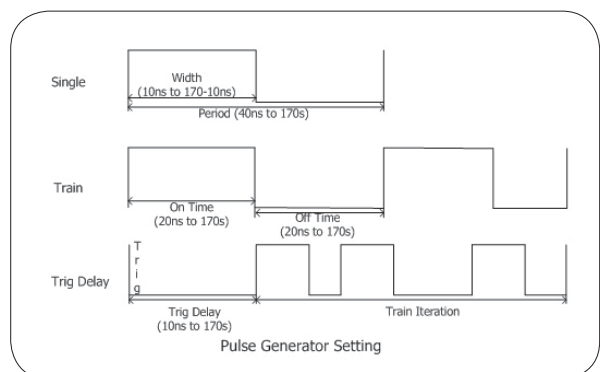

## Simultaneous Modulation

	AM	FM	ØM	Pulse mod. (opt.)
AM	—	○	○	△
FM	○	—	×	○
ØM	○	×	—	○
Pulse mod. (opt.)	△	○	○	—

Note: ○: Compatible; ×: Not compatible; △: Compatible, but the AM performance will decrease when pulse modulation is turned on.

## Key Specifications

Models		DSG815	DSG830	DSG821	DSG821A	DSG836	DSG836A
Frequency range		9kHz-1.5GHz	9kHz-3GHz	9kHz- 2.1GHz	9kHz- 2.1GHz	9kHz- 3.6GHz	9kHz-3.6GHz
Amplitude Output Level		-110dBm - +13dBm					
Amplitude Setting Level		-110dBm - +20dBm					
Level uncertainty		<0.9dB (< 0.5dB typ.)					
Clock stability		< 2ppm, <5ppb(With option OCXO-B08)					
Spectral Purity	SSB phase noise	100 kHz ≤ f ≤ 1.5 GHz, <-105dBc/Hz(-112dBc/Hz typ.) 1.5 GHz < f ≤ 3.6 GHz, < -99 dBc/Hz(< -106 dBc/Hz typ.), CW mode, carrier offset = 20 kHz					
	Harmonic	<-30dBc CW mode 1MHz ≤ f ≤ 3GHz, Level ≤ +13dBm					
	Non-harmonic	100kHz ≤ f ≤ 1.5GHz, <-60dBc (<-70dBc typ. ); 1.5GHz ≤ f ≤ 3GHz, <-54dBc/Hz(<-64dBc/Hz typ. )					
Sweep	Sweep type	Linear sweep, Step/List sweep, Single/Continue sweep					
	Sweep points	2 ~65535(Step sweep); 1-6001 (List sweep)					
Modulation type		AM, FM, ØM, Pulse mod					
AM	modulation depth	0%-100%					
	Uncertainty	< setting value x 4% + 1%					
	Modulation frequency response	<3dB(10Hz ~ 100kHz m<80%)					
FM	Max. deviation	N <sup>[1]</sup> x 1MHz					
	Uncertainty	< setting value x 2% + 20Hz					
	Modulation frequency response	<3dB(10Hz – 100kHz)					
PM	Max. deviation	N <sup>[1]</sup> x 5rad					
	Uncertainty	< setting value x 1% + 0.1rad					
	Modulation frequency response	<3dB(10Hz – 100kHz)					
Pulse Modulation	On/off ratio	>70dB(100kHz ≤ f <3GHz)					
	Rise/fall time	<50ns, 10ns (typ.)					
	Pulse mode	Single pulse, pulse train (option DSG800-PUG)					
I/Q modulation (only for A type model)	Bandwidth	Bandwidth: External modulation: baseband (I or Q): up to 60 MHz; RF(I+Q): up to 120 MHz External modulation: baseband (I or Q): up to 30MHz; RF(I+Q): up to 60MHz					
	EVM	≤ 2%rms (typ.)					
General	Interfaces	Std.: USB, LAN					
		Front Panel: RF output, Internal modulation generator (LF) output					
		Rear Panel: External trigger input, Signal valid output, Pulse input or output					
		External modulating signal input, 10MHz input/output					

Note[1]:

f < 227.5 MHz, N=0.25; 227.5 MHz ≤ f < 455 MHz, N=0.125; 455 MHz ≤ f < 910 MHz, N=0.25; 910 MHz ≤ f < 1820 MHz, N=0.5; 1820 MHz ≤ f ≤ 3600 MHz, N=1

## Ordering Information

	Description	Order Number
Models	DSG830 RF Signal Generator, 9kHz-3GHz	DSG830
	DSG815 RF Signal Generator, 9kHz-1.5GHz	DSG815
	DGS821 RF Signal Generator, 9kHz-2.1GHz	DSG821
	DGS821A RF Signal Generator, 9kHz-2.1GHz, with I/Q modulation	DSG821A
	DGS836 RF Signal Generator, 9kHz-3.6GHz	DSG836
	DGS836 RF Signal Generator, 9kHz-3.6GHz, with I/Q modulation	DSG836A
Standard Accessories	Power Cable	-
Options	Pulse Modulation, Pulse Generator	DSG800-PUM
	Pulse Train Generator (DSG800-PUM Included)	DSG800-PUG
	High Stable Reference Clock(Need to be installed before leaving the factory)	OCXO-B08
	Rack Mount Kit (For one Instrument)	RM-1-DG1000Z
	Rack Mount Kit (For two Instrument)	RM-2-DG1000Z



# Function/Arbitrary Waveform Generators



RIGOL's Function / Arbitrary Waveform generator adopts the latest Direct Digital Frequency Synthesis technology (DDS) to generate accurate and stable regular waveforms (such as sine waves and square waves) as well as the Analog or Digital modulated signals. What's more, the generator also provides arbitrary waveform function which allows engineers to generate any desired waveforms either using the UltraWave arbitrary waveform editing software or using the oscilloscope to capture the actual signal and then downloading it to the generator. The digital sampling technology and the Direct Digital Frequency

Synthesis technology enable engineers to generate any desired waveform for circuit verification design.

RIGOL has introduced a complete range of Function / Arbitrary Waveform generators in the past years includes DG1000Z, DG2000, DG4000, DG5000, DG900 and DG800 series with up to 350MHz frequency, 1 GSa/s sample rate, 16 bits vertical resolution, 128M points arbitrary waveform memory. The rich features let RIGOL's generators to be the excellent circuit debug tools for engineers.

	Max. Output Frequency(MHz)													Channels	Max. Sample rate	Max. Arb Memory Depth	waveform generation technology	Modulation Types
	10	25	30	35	50	60	70	100	160	200	250	350						
DG800	•	•		•										1/2	125MSa/s	2M (8M Opt.)	SiFi II	AM,FM,PM,ASK,FSK, PSK,PWM
DG900					•		•	•						2	250MSa/s	16M	SiFi II	AM,FM,PM,ASK,FSK, PSK,PWM
DG1000Z		•	•			•								2	250MSa/s	8M/2M (DG1022Z) (16M Opt.)	SiFi II	AM,FM,PM,ASK, FSK,PSK,PWM
DG2000					•		•	•						2	250MSa/s	16M	SiFi II	AM,FM,PM,ASK, FSK,PSK,PWM
DG4000						•		•	•	•				2	500MSa/s	16K	DDS	AM,FM,PM,ASK,FSK, PSK,BPSK,QPSK,3FSK, 4FSK,OSK,PWM
DG5000							•	•				•	•	1/2	1GSa/s	128M	DDS	AM,FM,PM,ASK,FSK, PSK,PWM,IQ

# DG5000 Series Function/Arbitrary Waveform Generators



DG5000 is a multifunctional generator that combines many functions in one, including Function Generator, Arbitrary Waveform Generator, IQ Baseband Source/IQ IF Source, Frequency Hopping Source (optional) and Pattern Generator (optional). DG5000 can provide stable, precise, pure and low distortion signal by adopting the Direct Digital Synthesizer (DDS) technology. It provides single

and dual-channel models. The dual-channel model, with two channels having complete equivalent functions and precisely adjustable phase deviation between the two channels, is a real dual-channel signal generator.

- Arb function with 1 GSa/s sample rate, 14 bits vertical resolution
- Support internal and external IQ modulation
- Whole range of Analog/Digital modulation functions (standard)
- Various Sweep Types (standard)
- Intuitive Constellation setup and display
- Support Frequency Hopping function (option)
- Complete connectivity, support Parallel Bus output (Option)

Arb function with 1 GSa/s sample rate, 14 bits vertical resolution

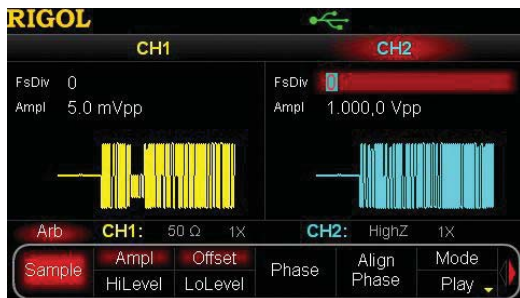

Intuitive Constellation setup and display

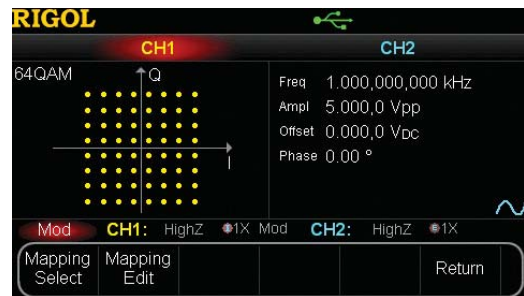

Various Sweep Types (standard)

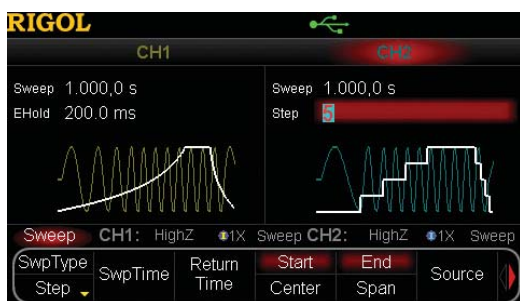

Support Frequency Hopping function (option)

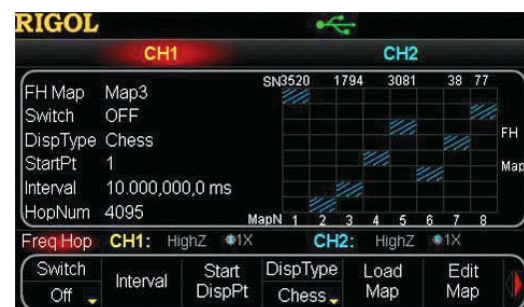

Support internal and external IQ modulation

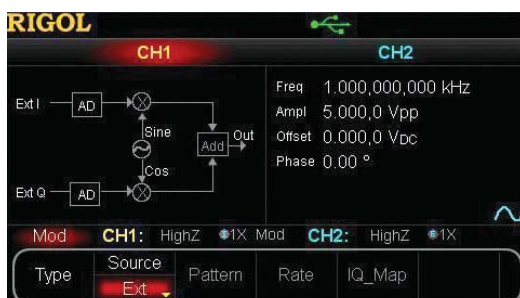

Complete connectivity, support Parallel Bus output (Option)



## Key Specifications

Model	DG5351/2	DG5251/2	DG5101/2	DG5071/2
Channel	1/2	1/2	1/2	1/2
Maximum Frequency	350MHz	250MHz	100MHz	70MHz
Sample Rate	1GSa/s			
Waveforms	Standard Waveforms: Sine, Square, Ramp, Pulse, Noise Arbitrary Waveforms: Sinc, Exponential Rise, Exponential Fall, ECG, Gauss, HaverSine, Lorentz, Dual-Tone, DC, User defined			
Frequency Characteristics				
Sine	1uHz-350MHz	1uHz-250MHz	1uHz-100MHz	1uHz-70MHz
Square	1uHz-120MHz	1uHz-120MHz	1uHz-100MHz	1uHz-70MHz
Ramp	1uHz-5MHz	1uHz-5MHz	1uHz-3MHz	1uHz-3MHz
Pulse	1uHz-50MHz			
Noise	250MHz			
Arb	1uHz-50MHz			
Waveform Length	128M (std.)			
Sine Wave Spectrum Purity	Total Harmonic Distortion: <0.5%(10Hz-20KHz,0dBm); Phase Noise: <-110dBc@10MHz (0dBm,10KHz offset)			
Square Rise/Fall Time	<2.5ns	<2.5ns	<3ns	<4ns
Jitter (rms)	≤ 30MHz: 10ppm+500ps, >30MHz: 500ps			
Amplitude (into 50 Ω)	≤ 100MHz: 5mVpp-10Vpp; ≤ 300MHz:5mVpp-5Vpp; ≤ 350MHz:5mV-2Vpp			
IQ Modulation	4QAM,8QAm,16QAM,32QAM,64QAM,BPSK,QPSK,OQPSK,8PSK,16PSK,user; Symbol Rate: 1bps to 1Mbps; Carrier Waveform: Sine (max.200MHz)			
FH Characteristic	FH Bandwidth 1.5MHz-250MHz; FH Rate: 1 Hop/s to 12.5M Hop/s; Frequency Point Numbers:4096			
Burst Characteristics	Carrier Frequency 1uHz-120MHz, Burst Count: 1 to 1 000 000 or Infinite			

## Ordering Information

	Description	Order Number
Models	DG5352 (350 MHz, dual-channel, 128Mpts)	DG5352
	DG5351 (350 MHz, single-channel, 128Mpts)	DG5351
	DG5252 (250 MHz, dual-channel, 128Mpts)	DG5252
	DG5251 (250 MHz, single-channel, 128Mpts)	DG5251
	DG5102 (100 MHz, dual-channel, 128Mpts)	DG5102
	DG5101 (100 MHz, single-channel, 128Mpts)	DG5101
	DG5072 (70MHz, dual-channel, 128Mpts)	DG5072
	DG5071 (70MHz, single-channel, 128Mpts)	DG5071
Standard Accessories	USB Cable	CB-USBA-USBB-FF-150
	BNC Cable (1 meter)	CB-BNC-BNC-MM-100
	SMB(F) to BNC(M) Cable (1 meter)	CB-SMB-BNC-FM-100
	Power Cord Conforming to the Standard of the Destination Country	-
Options	Frequency Hopping Module	FH-DG5000
	Advanced Function of Arbitrary Waveform Editing PC Software (advanced function)	Ultra Station-adv
	Power Amplifier	PA1011
	40 dB Attenuator	RA5040K
	Rack Mount Kit	RM-DG5000

# DG4000 Series Function/Arbitrary Waveform Generators



DG4000 series is a multifunctional generator that integrates many functions into one, including Function Generator, Arbitrary Waveform Generator, Pulse Generator, Harmonic Generator,

Analog/Digital Modulator and Counter. DG4000 can provide stable, precise, pure and low distortion signal by adopting the Direct Digital Synthesizer (DDS) technology. All the models have two channels with complete equivalent functions and precisely phase adjustable, they are the real dual-channel signal generator.

- 7 inch color LCD
- Arbitrary waveform function and built-in 150 waveform
- Abundant analog and digital modulation function
- Various Sweep modes
- Noise and Burst modes
- Up to 16 orders customized Harmonic generation function

Standard 2 identical channels with frequency and phase coupling

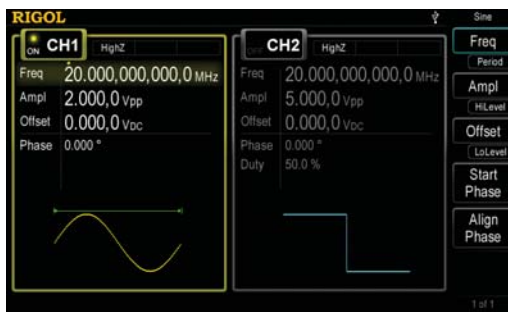

Various Sweep modes

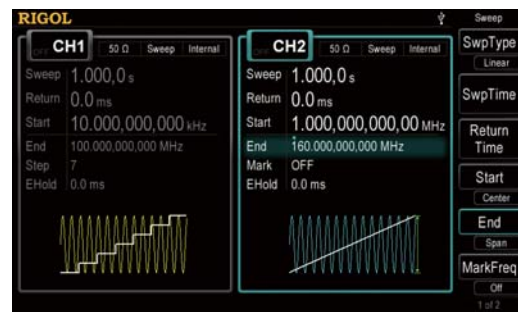

Arbitrary waveform function and built-in 150 waveform

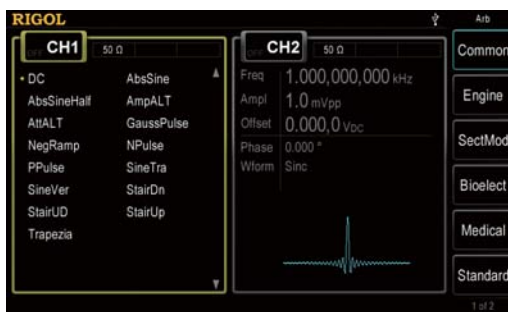

Noise and Burst modes

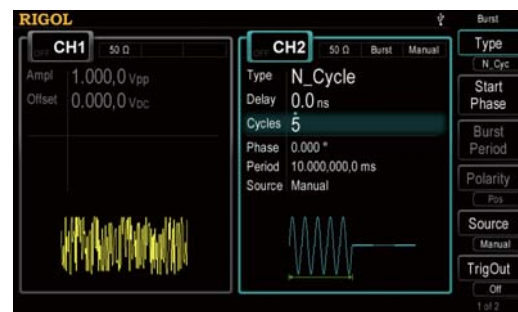

Abundant analog and digital modulation function

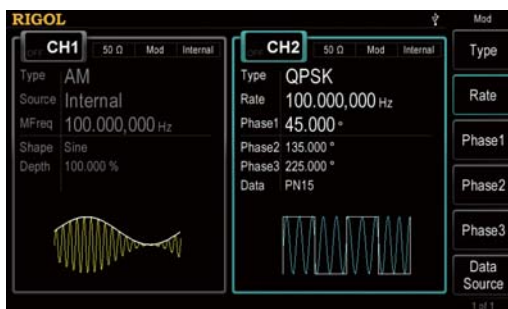

Standard 7digits/s counter with statistic analysis

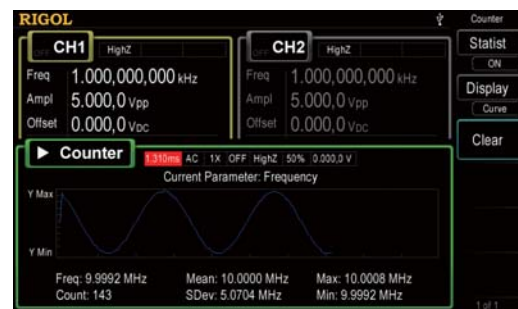

## Key Specifications

Model	DG4202	DG4162	DG4102	DG4062
Channel	2			
Maximum Frequency	200MHz	160MHz	100MHz	60MHz
Sample Rate	500Msa/s			
Waveforms	Standard Waveforms: Sine, Square, Ramp, Pulse, Noise, Harmonics ( up to 16 orders) Arbitrary Waveforms: Sinc, Exponential Rise, Exponential Fall, ECG, Gauss, HaverSine, Lorentz, Dual-Tone, DC, etc. up to 150 waveforms			
Waveform Length	16K			
Vertical Resolution	14bits			
Sine	1uHz-200MHz	1uHz-160MHz	1uHz-100MHz	1uHz-60MHz
Square	1uHz-60MHz	1uHz-50MHz	1uHz-40MHz	1uHz-25MHz
Ramp	1uHz-5MHz	1uHz-4MHz	1uHz-3MHz	1uHz-1MHz
Pulse/arb	1uHz-50MHz	1uHz-40MHz	1uHz-25MHz	1uHz-15MHz
Noise (-3dB)	120MHz	120MHz	80MHz	60MHz
Sine Wave Spectrum Purity	Total Harmonic Distortion : <0.1%(10Hz-20KHz,0dBm); Phase Noise : ≤ -115dBc@10MHz (0dBm,10KHz offset)			
Square Rise/Fall Time	<8ns	<8ns	<10ns	<12ns
Jitter (rms)	≤ 5MHz: 2ppm+500ps, >5MHz : 500ps			
Amplitude (into 50 Ω)	≤ 20MHz: 1mVpp-10Vpp; ≤ 60MHz:1mVpp-5Vpp; ≤ 120MHz:1mV-2.5Vpp; ≤ 200MHz:1mV-1Vpp			
Modulation Type	AM, FM, PM, ASK, FSK, PSK, BPSK, QPSK, 3FSK, 4FSK, OSK, PWM			
Work Mode	Continue, Burst, Sweep, Modulation			
Burst Characteristics	Carrier Frequency 2mHz-100MHz, Burst Count : 1 to 1 000 000 or Infinite; trigger source: internal, external, manual			

## Ordering Information

	Description	Order Number
Models	DG4202 (200 MHz, dual-channel)	DG4202
	DG4162 (160 MHz, dual-channel)	DG4162
	DG4102 (100 MHz, dual-channel)	DG4102
	DG4062 ( 60 MHz, dual-channel)	DG4062
Standard Accessories	USB Cable	CB-USBA-USBB-FF-150
	BNC Cable (1 meter)	CB-BNC-BNC-MM-100
	Power Cord Conforming to the Standard of the Destination Country	-
Optional Accessories	Arbitrary Waveform Editing PC Software (advanced function)	Ultra Station-adv
	40 dB Attenuator	RA5040K
	Rack Mount Kit	RM-DG4000
	USB-GPIB Module	USB-GPIB

# DG2000 Series Function/Arbitrary Waveform Generators



As a multi-functional signal generator, DG2000 series function/arbitrary waveform generator integrates many instruments into 1, such as function generator, arbitrary waveform generator, noise generator, pulse generator, pattern generator, harmonic generator, analog/digital modulator, and frequency counter. The brand new

appearance and user-friendly interface design bring you excellent user experience. DG2000 series function/arbitrary waveform generator is the upgrade version of DG900. With the newly added standard waveform key, users can switch the standard waveforms freely and conveniently. Besides, with 1UH in width and 2U in height, the DG2000 series function/arbitrary waveform generator is more suitable for the demand of integration test.

- SiFi II technology, generating the arbitrary waveforms points by points, outputting high-quality waveforms accurately
- Built-in 8 orders harmonics generator
- Up to 250 Msa/s sample rate and 16 M memory depth
- 4.3" TFT color touch screen and brand new UI design
- PRBS, RS232, and Sequence
- Fan-free mute design

## Unique SiFi II Technology



## PRBS, RS232 Pattern, and Sequence



## Touch-enabled UI Design (Drag)

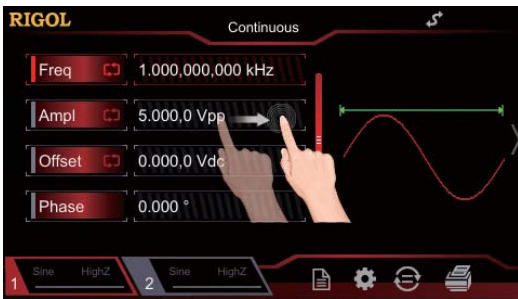

## Touch-enabled UI Design (Tap)

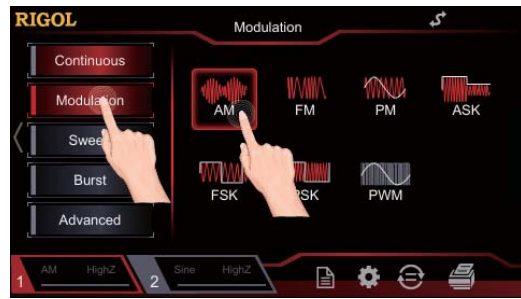

## 100 MHz Bandwidth White Gaussian Noise

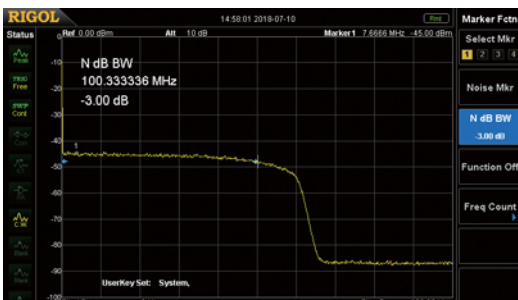

## Key Specifications

Model	DG2052	DG2072	DG2102
Channel	2		
Max. Output Frequency	50MHz	70MHz	100MHz
Sample Rate	250MSa/s		
Waveform Type	Standard Waveform: Sine, Square, Ramp, Pulse, Noise, Dual-tone, Harmonic (up to 8 orders) Arbitrary Waveform: 160 types of waveforms, including Sinc, Exponential Rise, Exponential Fall, ECG, Gauss, HaverSine, Lorentz, Dual-tone, and DC Advanced Waveform: PRBS, RS232, and Sequence		
Arbitrary Waveform Length	16Mpts		
Vertical Resolution	16bits		
Sine	1uHz-50MHz	1uHz-70MHz	1uHz-100MHz
Square	1uHz-15MHz	1uHz-20MHz	1uHz-25MHz
Ramp	1uHz-1.5MHz	1uHz-1.5MHz	1uHz-2MHz
Pulse	1uHz-15MHz	1uHz-20MHz	1uHz-25MHz
Arbitrary Waveform	1uHz-15MHz	1uHz-20MHz	1uHz-20MHz
Harmonic	1uHz-20MHz	1uHz-20MHz	1uHz-25MHz
Dual-tone	1uHz-20MHz	1uHz-20MHz	1uHz-20MHz
RS232	Baud rate range: 9600, 14400, 19200, 38400, 57600, 115200, 128000, 230400		
PRBS	2kbps-40Mbps	2kbps-50Mbps	2kbps-60Mbps
Sequence	2k-60MSa/s		
Noise (-3 dB)	100 MHz Bandwidth		
Sine Wave Spectrum Purity	Total harmonic distortion: <0.075% (10 Hz to 20 kHz, 0 dBm); phase noise: <-105 dBc/Hz@10 MHz (0 dBm, 10 kHz offset)		
Square Rise/Fall Time	Typical (1 Vpp) ≤ 9 ns		
Jitter	Typical (1 Vpp) ≤ 5 MHz: 2 ppm + 200 ps > 5 MHz: 200 ps		
Output Amplitude (into 50 Ω)	≤10 MHz: 1 mVpp-10 Vpp; ≤30 MHz: 1 mVpp-5 Vpp; ≤60 MHz: 1 mV-2.5 Vpp; >60 MHz: 1 mV-2.5 Vpp		
Modulation Type	AM, FM, PM, ASK, FSK, PSK, and PWM		
Working Mode	Continuous, Burst, Sweep, and Modulation		
Burst Characteristics	Carrier frequency 2 MHz-10 MHz/25 MHz/35 MHz/50 MHz/70 MHz/100 MHz; Pulse count: 1-1 M or Infinite; trigger source: external, internal, and manual		
Standard Interface	USB Device (on the rear panel) and USB Host		

## Ordering Information

	Description	Order No.
	DG2052 (50 MHz, Dual-channel)	DG2052
	DG2072(70 MHz, Dual-channel)	DG2072
	DG2102 (100MHz, Dual-channel)	DG2102
Standard Accessories	Power Cord Conforming to the Standard of the Destination Country	-
	USB Cable	CB-USBA-USBB-FF-150
	BNC Cable	CB-BNC-BNC-MM-100
	Product Warranty Card	-
Optional Accessories	40 dB Attenuator	RA5040K
	Arbitrary Waveform Editing PC Software (advanced function)	Ultra Station-adv
	Rack Mount Kit (single instrument)	RM-1-DG1000Z
	Rack Mount Kit (two instruments)	RM-2-DG1000Z
	USB-GPIB Interface Converter	USB-GPIB-L

# DG1000Z Series Function/Arbitrary Waveform Generators



DG1000Z series function/arbitrary waveform generator is a multi-functional generator that combines many functions in one, including Function Generator, Arbitrary Waveform Generator, Noise Generator, Pulse Generator, Harmonics Generator, Analog/Digital Modulator and Counter.

The maximum output frequency (Sine) of DG1000Z is 25MHz/30MHz/60MHz. It provides 2 full functional channels with precisely phase adjustable. The standard interfaces are USB and LAN.

- Innovative SiFi technology
- Up to 160 built-in waveforms
- Multiple analog and digital modulations
- Standard harmonic generator
- Waveform summing function
- Standard 7 digits/s full function frequency counter

## Standard 2 full functional channels

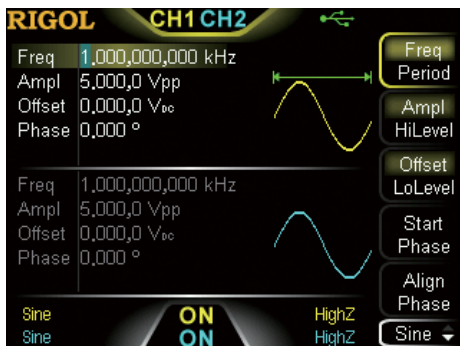

## Arbitrary waveform function with innovative SiFi technology

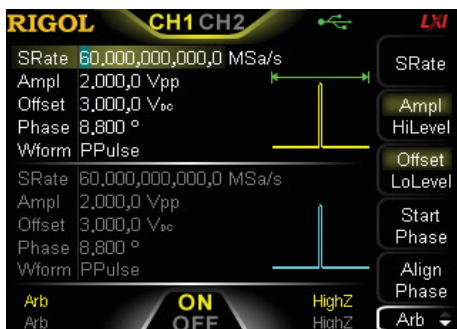

## Up to 160 built-in waveforms



## Multiple analog and digital modulations

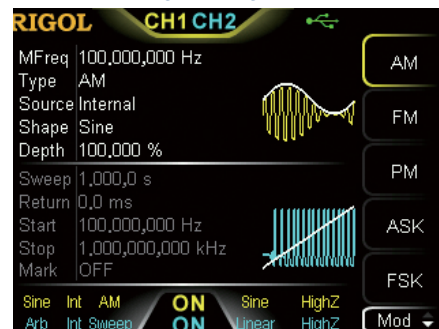

## Standard harmonic generator



## Burst function

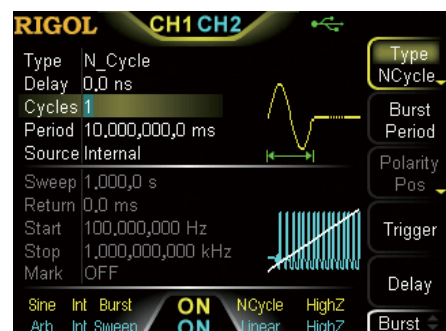



## Key Specifications

Model	DG1062Z	DG1032Z	DG1022Z
Channel	2		
Maximum Frequency	60MHz	30MHz	25MHz
Sample Rate	200Msa/s		
Waveforms	Waveforms Standard Waveforms: Sine, Square, Ramp, Pulse, Noise, Harmonics ( up to 8 orders) Arbitrary Waveforms: Sinc, Exponential Rise, Exponential Fall, ECG, Gauss, HaverSine, Lorentz, Dual-Tone, DC, etc. up to 160 waveforms		
Waveform Length	8pts to 8Mpts, optional 16Mpts		8pts to 2Mpts, optional 16Mpts
Vertical Resolution	14bits		
Sine	1uHz-60MHz	1uHz-30MHz	1uHz-25MHz
Square	1uHz-25MHz	1uHz-25MHz	1uHz-25MHz
Ramp	1uHz-1MHz	1uHz-500KHz	1uHz-500KHz
Pulse	1uHz-25MHz	1uHz-15MHz	1uHz-15MHz
Arb/Harmonics	1uHz-20MHz	1uHz-10MHz	1uHz-10MHz
Noise (-3dB)	60MHz BW	30MHz BW	25MHz BW
Sine Wave Spectrum Purity	Total Harmonic Distortion <0.075%(10Hz-20KHz,0dBm); Phase Noise <-125dBc@10MHz (0dBm,10KHz offset)		
Square Rise/Fall Time	Typ. (1Vpp) <10ns		
Jitter (rms)	Typ. (1Vpp) ≤ 5MHz: 2ppm+200ps, >5MHz : 200ps		
Amplitude (into 50 Ω)	≤10MHz, 1 mVpp-10Vpp; ≤30MHz:1 mVpp-5Vpp; ≤60MHz:1 mV-2.5Vpp		
Modulation Type	AM, FM, PM, ASK, FSK, PSK, PWM		
Work Mode	Continue, Burst, Sweep, Modulation		
Burst Characteristics	Carrier Frequency 2mHz-25MHz/30MHz/60MHz, Burst Count, 1 to 1 000 000 or Infinite; Trigger source: internal, external, manual		
Standard Interfaces	USB (Device), USB (Host), LAN (LXI-C), USB-GPIB (Opt).		

## Ordering Information

	Description	Order Number
Models	DG1022Z (25MHz, Dual-channel)	DG1022Z
	DG1032Z (30MHz, Dual-channel)	DG1032Z
	DG1062Z (60MHz, Dual-channel)	DG1062Z
Standard Accessories	USB Cable	CB-USBA-USBB-FF-150
	BNC Cable (1 meter)	CB-BNC-BNC-MM-100
	Power Cord Conforming to the Standard of the Destination Country	-
Optional Accessories	16Mpts Memory for Arb	ARB16M-DG1000Z
	Arbitrary Waveform Editing PC Software (advanced function)	Ultra Station-adv
	40dB Attenuator	RA5040K
	10W Power Amplifier	PA1011
	Rack Mount Kit (for single instrument)	RM-1-DG1000Z
	Rack Mount Kit (for dual instruments)	RM-2-DG1000Z
	USB-GPIB module	USB-GPIB

# DG900 Series Function/Arbitrary Waveform Generators



As a multi-functional signal generator, DG900 series function/arbitrary waveform generator integrates many instruments into 1, such as function generator, arbitrary waveform generator, noise generator, pulse generator, pattern generator, harmonic generator, analog/digital modulator, and frequency counter. The brand new appearance and user-friendly interface design bring you excellent user experience.

- SiFi II technology, generating the arbitrary waveforms points by points, outputting high-quality waveforms accurately
- Built-in 8 orders harmonics generator
- Up to 250 Msa/s sample rate and 16 M memory depth
- 4.3" TFT color touch screen and brand new UI design
- PRBS, RS232, and Sequence
- Fan-free mute design

## Unique SiFi II Technology



## PRBS, RS232 Pattern, and Sequence



## Touch-enabled UI Design (Drag)

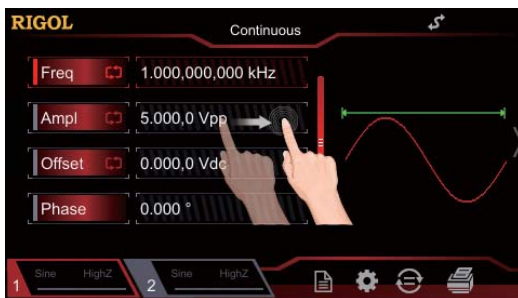

## Touch-enabled UI Design (Tap)

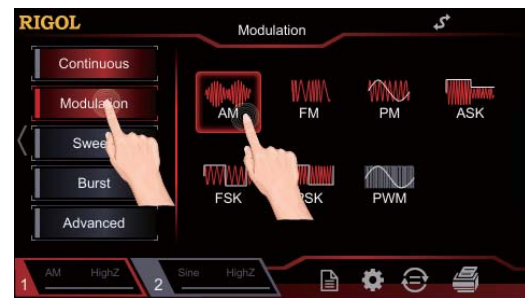

## 100 MHz Bandwidth White Gaussian Noise

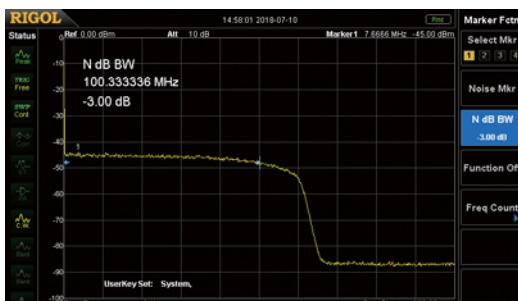

## Fan-free Mute Design

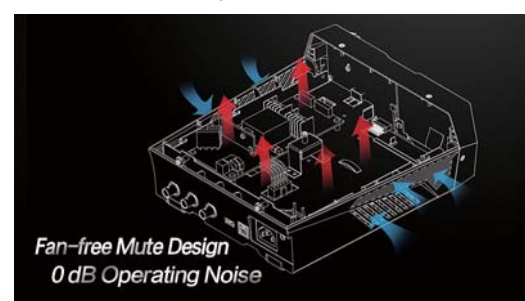

## Key Specifications

Model	DG952	DG972	DG992
Channel	2		
Max. Output Frequency	50MHz	70MHz	100MHz
Sample Rate	250MSa/s		
Waveform Type	Standard Waveform: Sine, Square, Ramp, Pulse, Noise, Dual-tone, Harmonic (up to 8 orders) Arbitrary Waveform: 160 types of waveforms, including Sinc, Exponential Rise, Exponential Fall, ECG, Gauss, HaverSine, Lorentz, Dual-tone, and DC Advanced Waveform: PRBS, RS232, and Sequence		
Arbitrary Waveform Length	16Mpts		
Vertical Resolution	16bits		
Sine	1uHz-50MHz	1uHz-70MHz	1uHz-100MHz
Square	1uHz-15MHz	1uHz-20MHz	1uHz-25MHz
Ramp	1uHz-1.5MHz	1uHz-1.5MHz	1uHz-2MHz
Pulse	1uHz-15MHz	1uHz-20MHz	1uHz-25MHz
Arbitrary Waveform	1uHz-15MHz	1uHz-20MHz	1uHz-20MHz
Harmonic	1uHz-20MHz	1uHz-20MHz	1uHz-25MHz
Dual-tone	1uHz-20MHz	1uHz-20MHz	1uHz-20MHz
RS232	Baud rate range: 9600, 14400, 19200, 38400, 57600, 115200, 128000, 230400		
PRBS	2kbps-40Mbps	2kbps-50Mbps	2kbps-60Mbps
Sequence	2k-60MSa/s		
Noise (-3 dB)	100 MHz Bandwidth		
Sine Wave Spectrum Purity	Total harmonic distortion: <0.075% (10 Hz to 20 kHz, 0 dBm); phase noise: <-105 dBc/Hz@10 MHz (0 dBm, 10 kHz offset)		
Square Rise/Fall Time	Typical (1 Vpp) $\leq$ 9 ns		
Jitter	Typical (1 Vpp) $\leq$ 5 MHz: 2 ppm + 200 ps > 5 MHz: 200 ps		
Output Amplitude (into 50 $\Omega$ )	$\leq$ 10 MHz: 1 mVpp-10 Vpp; $\leq$ 30 MHz: 1 mVpp-5 Vpp; $\leq$ 60 MHz: 1 mV-2.5 Vpp; >60 MHz: 1 mV-2.5 Vpp		
Modulation Type	AM, FM, PM, ASK, FSK, PSK, and PWM		
Working Mode	Continuous, Burst, Sweep, and Modulation		
Burst Characteristics	Carrier frequency 2 MHz-10 MHz/25 MHz/35 MHz/50 MHz/70 MHz/100 MHz; Pulse count: 1-1 M or Infinite; trigger source: external, internal, and manual		
Standard Interface	USB Device (on the rear panel) and USB Host		

## Ordering Information

	Description	Order No.
Models	DG952 (50 MHz, Dual-channel)	DG952
	DG972 (70 MHz, Dual-channel)	DG972
	DG992 (100 MHz, Dual-channel)	DG992
Standard Accessories	Power Cord Conforming to the Standard of the Destination Country	-
	USB Cable	CB-USBA-USBB-FF-150
	BNC Cable	CB-BNC-BNC-MM-100
	Product Warranty Card	-
Optional Accessories	40 dB Attenuator	RA5040K
	Arbitrary Waveform Editing PC Software (advanced function)	Ultra Station-adv
	USB-GPIB Interface Converter	USB-GPIB-L

# DG800 Series Function/Arbitrary Waveform Generators



As a multi-functional signal generator, DG800 series function/arbitrary waveform generator integrates many instruments into 1, such as function generator, arbitrary waveform generator, noise

generator, pulse generator, pattern generator, harmonic generator, analog/digital modulator, and frequency counter. The brand new appearance and user-friendly interface design bring you excellent user experience.

- SiFi II technology, generating arbitrary waveforms points by points, outputting high-quality waveforms accurately
- Built-in 8 orders harmonics generator
- Standard waveform combination and channel tracking function
- 4.3" TFT color touch screen and brand new UI design
- PRBS, RS232, and Sequence output
- Fan-free mute design

## Unique SiFi II Technology



## PRBS, RS232 Pattern, and Sequence



## Touch-enabled UI Design (Drag)

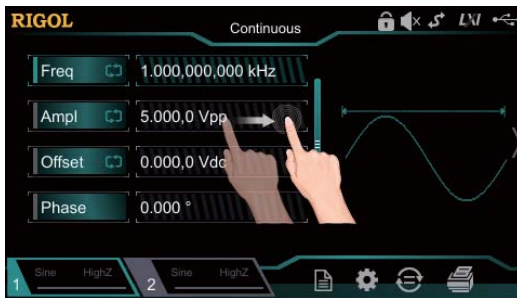

## Touch-enabled UI Design (Tap)

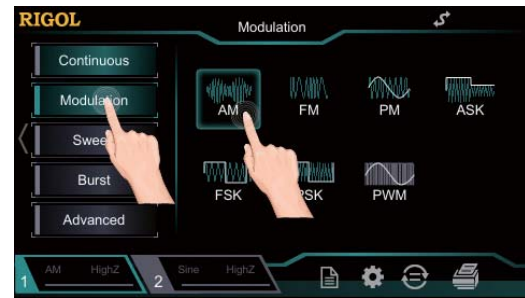

## 100 MHz Bandwidth White Gaussian Noise

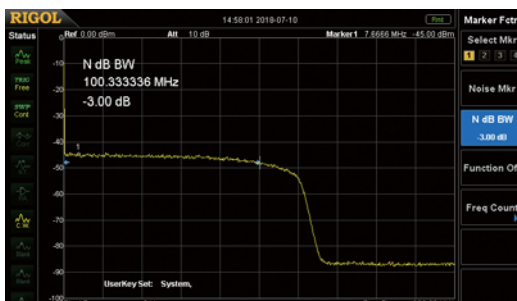

## Fan-free Mute Design

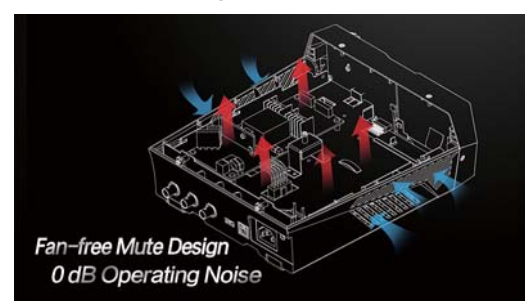

## Key Specifications

Model	DG811/2	DG821/2	DG831/2
Channel	1/2		
Max. Output Frequency	10MHz	25MHz	35MHz
Sample Rate	125MSa/s		
Waveform Type	Standard Waveform: Sine, Square, Ramp, Pulse, Noise, Dual-tone, Harmonic (up to 8 orders) Arbitrary Waveform: 160 types of waveforms, including Sinc, Exponential Rise, Exponential Fall, ECG, Gauss, HaverSine, Lorentz, Dual-tone, and DC Advanced Waveform: PRBS, RS232, and Sequence		
Arbitrary Waveform Length	2Mpts (opt.8Mpts)		
Vertical Resolution	16bits		
Sine	1uHz-10MHz	1uHz-25MHz	1uHz-35MHz
Square	1uHz-5MHz	1uHz-10MHz	1uHz-10MHz
Ramp	1uHz-200KHz	1uHz-500KHz	1uHz-1MHz
Pulse	1uHz-5MHz	1uHz-10MHz	1uHz-10MHz
Arbitrary Waveform	1uHz-5MHz	1uHz-10MHz	1uHz-10MHz
Harmonic	1uHz-5MHz	1uHz-10MHz	1uHz-15MHz
Dual-tone	1uHz-10MHz	1uHz-20MHz	1uHz-20MHz
RS232	Baud rate range: 9600, 14400, 19200, 38400, 57600, 115200, 128000, 230400		
PRBS	2kbps-10Mbps	2kbps-20Mbps	2kbps-30Mbps
Sequence	2k to 30 MSa/s		
Noise (-3 dB)	100 MHz Bandwidth		
Sine Wave Spectrum Purity	Total harmonic distortion: <0.075% (10 Hz to 20 kHz, 0 dBm); phase noise: <-105 dBc/Hz@10 MHz (0 dBm, 10 kHz offset)		
Square Rise/Fall Time	Typical (1 Vpp) ≤ 9 ns		
Jitter	Typical (1 Vpp) ≤ 5 MHz: 2 ppm + 200 ps > 5 MHz: 200 ps		
Output Amplitude (into 50 Ω)	≤10MHz: 1 mVpp-10 Vpp; ≤30 MHz: 1 mVpp-5 Vpp; ≤60 MHz: 1 mV-2.5 Vpp; > 60 MHz: 1 mV-2.5 Vpp		
Modulation Type	AM, FM, PM, ASK, FSK, PSK, and PWM		
Working Mode	Continuous, Burst, Sweep, and Modulation		
Burst Characteristics	Carrier frequency 2 MHz-10 MHz/25 MHz/35 MHz/50 MHz/70 MHz/100 MHz; Pulse count: 1-1 M or Infinite; trigger source: external, internal, and manual		
Standard Interface	USB Device (on the rear panel) and USB Host		

## Ordering Information

	Description	Order No.
Models	DG812 (10 MHz, Dual-channel)	DG812
	DG822 (25 MHz, Dual-channel)	DG822
	DG832 (35 MHz, Dual-channel)	DG832
	DG811 (10 MHz, Single-channel)	DG811
	DG821 (25 MHz, Single-channel)	DG821
	DG831 (35 MHz, Single-channel)	DG831
Standard Accessories	Power Cord Conforming to the Standard of the Destination Country	-
	BNC Cable (only supplied by DG832/DG831/DG822/DG821)	CB-BNC-BNC-MM-100
	Product Warranty Card	-
Option	Dual-channel Option (only available for DG831/DG821/DG811)	DG800-DCH
	Arbitrary Waveform Editing PC Software (advanced function)	Ultra Station-adv
	2M-8M Arbitrary Waveform Memory Depth Upgrade Option	DG800-ARB8M
Optional Accessories	40 dB Attenuator	RA5040K
	USB-GPIB Interface Converter	USB-GPIB-L

# Digital Multimeters



DM3000 series Digital multimeters (DM3068, DM3058, DM3058E) are the products designed with multi-functions, high-precision, high performance and automatic measurements, they are integrated with the features of high-speed data acquisition, high precision, high stability, support any type of sensors, complete interfaces.

They have complete interface such as RS-232, USB, LAN (LXI-C) and GPIB, they support the U disk storage. It's easy to be

connected to the PC by the USB or LAN. They have been optimized for the production line automatic measurements with the PASS/FAIL control, unified power management, pre-programmed configurations, configuration setup cloning, fast measurement speed and noise immunity to improve the productivity. DM3000 series Digital multimeters are widely used in the areas of Research, Production line tests, Education, Quality Assurance, Service/ Maintenance, etc.

- 6 ½ (DM3068) or 5 ½ (DM3058/E) digits readings resolution
- Max. 10A Current Measurement Range
- Dual Measurements Display
- Support temperature sensors (TC, RTD and THERM) and user defined sensor
- Statistical analysis; Real-time Trend and Histogram display functions (DM3068)
- Abundant interfaces; Command compatible with main stream DMMs

Real 6½ digits readings resolution (DM3068)

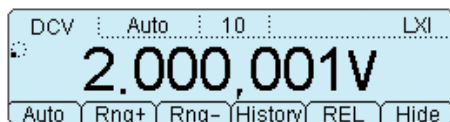

Easy to measure AC signal with double display

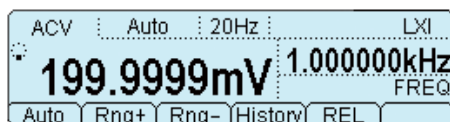

Standard Capacitor measurement function

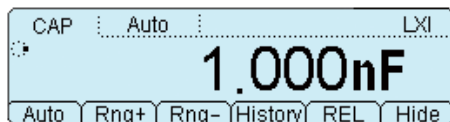

"Any sensor" function

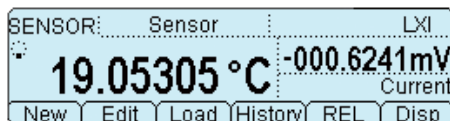

Support multiple temperature sensors

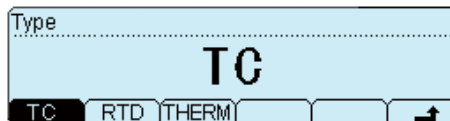

Support multiple commands

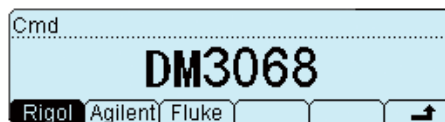

Trend display

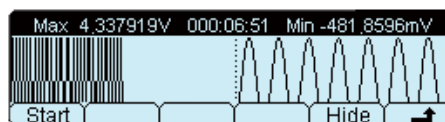

Histogram display

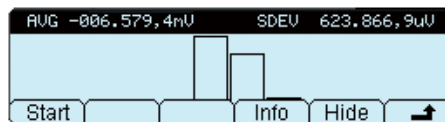

Pass/Fail test

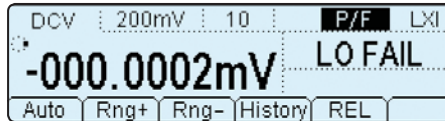

Clone all configurations from one instrument to another

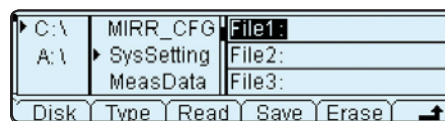

## Key Specifications

Function	Range	1Year Accuracy Specifications ± ( % of reading + % of range) (Tcal 23°C ±5°C )	
		DM3068	DM3058/E
DC Voltage	200.000mV ~ 1000.00V	0.0035 + 0.0006	0.015 + 0.003
DC Current	200.000uA ~ 10.0000A	0.030 + 0.003	0.055 + 0.005
AC Voltage (RMS)	200.000mV ~ 750.000V	0.06 + 0.04	0.2 + 0.05
AC Current (RMS)	200.0000uA ~ 10.00000A <sup>[1]</sup>	0.10 + 0.04	0.30+ 0.10
Resistance	200.000Ω ~ 100.000MΩ	0.010 + 0.001	0.020 + 0.003
Diode Test	2.000V/1mA	0.010 + 0.020	0.05 + 0.01
Continuity Test	2000.0Ω/1mA	0.010 + 0.020	0.05 + 0.01
Period/Frequency	3Hz-1MHz (200mV ~750V)	0.007	0.01+ 0.003
Capacitance	2.000nF ~ 100.0mF <sup>[2]</sup>	1 + 0.3	1+0.5
Max. Reading Speed		10000 rdgs /s	123 rdgs /s
Volatile Memory		512k readings of history records	2000 readings of history records
Remote Command		RIGOL, Agilent, FLUKE	

[1] DM3058/E ACI range: 20mA to 10A

[2] DM3058/E Cap range: 2nF to 10uF

## Ordering Information

	Description	Order Number
Models	DM3068: 6½ digits; standard interfaces: GPIB, LAN, USB, RS232	DM3068
	DM3058: 5½ digits; standard interfaces: GPIB, LAN, USB, RS232	DM3058
	DM3058E: 5½ digits; standard interfaces: USB, RS232	DM3058E
Standard Accessories	Two Test Leads (black and red)	LD-DM
	Two Alligator Clips (black and red)	ALLIGATORCLIP - DMM
	USB Cable	CB-USBA-USBB-FF-150
	Spare Fuses (DM3068: four; DM3058/E: two)	-
	Power Cord Conforming to the Standard of the Destination Country	-
Optional Accessories	Kelvin Test Clips	KELVINTTESTCLIP - DMM
	RS232 cable	CB-DB9-DB9-F-F-150
	Rack Mount Kit	RM-DM3000

# Data Acquisition/ Switch System



M300 Series Data Acquisition/Switch System with modular structure, which combines precision measurement capability with flexible signal connections, can provide versatile solutions for the applications with multiple points or signals to be tested in product performance test during R&D phase as well as automatic test during production process.

4.3" TFT LCD, easy for operation

6½ digit DMM can be inserted into any slot, supporting multiple measurement functions, including DCV, DCI, ACV, ACI, 2WR, 4WR, PERIOD, FREQ, TEMP and any sensor

Up to 320 switch channels per mainframe, save on cost of ownership

8 kinds of Modules supported

- Full Interfaces supported: USB Device, USB Host, GPIB, LAN(LXI-C), RS232
- Powerful PC software

## Measurement Configuration



## Draw real-time scan data curves

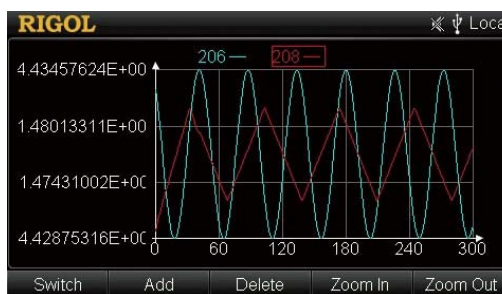

## Single Channel Monitor



## MC3648 Control Interface



## Display real-time scan information and all the measurement data



## MC3534 Control Interface

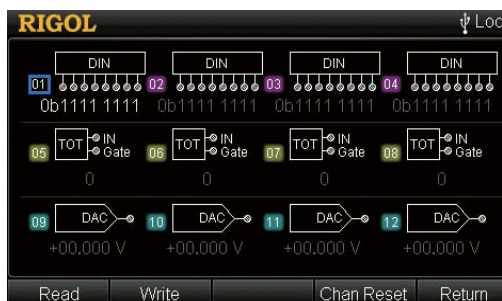



## Key Specifications

Module	Terminal Box	Channels				Description
		20	24	32	64	
MC3065	-					DMM module, 6½ digits, support functions: DCV, ACV, DCI, ACI, 2WR, 4WR, FREQ, PERIOD, TEMP and any sensor
MC3120	TB20	●				20-channel HI/LO (differential) input, Support 4-wire measurement
MC3132	TB32			●		32-channel HI/LO (differential) input, Support 4-wire measurement
MC3164	TB64				●	64-channel (single-ended), switch HI input only
MC3324	TB24		●			Mix multiplexer with 20 voltage channels and 4 current channels
MC3416	TB16					16-channel actuator that can connect signal to the device under test or enable external device
MC3534	TB34					Multifunction module. ·DIO: four 8-bit digital input/output ports ·TOT: four totalizer input terminals ·DAC: four analog output terminals
MC3648	TB48					4x8 two-wire matrix switch

## Ordering Information

	Description	Order Number
Mainframe	M300: Data Acquisition/Switch System	M300
	M301: Data Acquisition/Switch System + DMM Module	M301
	M302: Data Acquisition/Switch System + DMM Module+MC3120+M3TB20	M302
Module	DMM Module (6½ digits)	MC3065
	20-channel Multiplexer	MC3120 (Need to be used with M3TB20 together)
	32-channel Multiplexer	MC3132 (Need to be used with M3TB32 together)
	64-channel Single-ended Multiplexer	MC3164 (Need to be used with M3TB64 together)
	20-voltage-channel+4-current-channel Mixed Multiplexer	MC3324 (Need to be used with M3TB24 together)
	16-channel Actuator	MC3416 (Need to be used with M3TB16 together)
	Multifunction Module	MC3534 (Need to be used with M3TB34 together)
	4x8 Matrix Switch	MC3648 (Need to be used with M3TB48 together)
Terminal Box	MC3120 Terminal Box	M3TB20
	MC3324 Terminal Box	M3TB24
	MC3648 Terminal Box	M3TB48
	MC3534 Terminal Box	M3TB34
	MC3416 Terminal Box	M3TB16
	MC3132 Terminal Box	M3TB32
	MC3164 Terminal Box	M3TB64
Standard Accessories	USB Cable	CB-USBA-USBB-FF-150
	Mixed-interface Separator Line	MIX-SEPARATOR
	Power Cord	-
	Spare Fuses	-
Optional Accessories	RS232 Cable	CB-DB9-DB9-FF-150
	GPIB Reverse Entry for M300	M3GPIB
	External Port for Analog Bus Interface	M3A2B
	Rack Mount Kit	RM-1-M300
	Rack Mount Kit for Two Instruments	RM-2-M300
	M300 Series control and advanced data analysis PC Software	UltraAquire Pro

# Programmable DC Power Supplies



DP800 and DP700 Series are high-performance programmable linear DC power supply. All models of DP800 series have excellent features including standard timing outputs, extremely low ripple and noise, comprehensive over-voltage, over current, over-temperature protection, a large and clear user interface, super performance and specifications. DP800A models provide standard high resolution mode (1mV/1mA), fully remote control interfaces, On-line Monitoring and analysis functions; those functions are the options for DP800 models.

DP700 series power supply is a type of affordable programmable linear DC power supply with high performance. DP700 series also supports timing output and trigger function, and provides a remote control interface, the clear and simple user interface make it easy to use for the customers.

DP800 Series and DP700 Series have broad range of applications such as:

- Power supply for the R&D labs
- System integration
- Provide clean power for RF products
- Verification and characterisation for the device or circuit
- Teaching labs

Model	Outputs	Output Range	Max. Power	Ripple & Noise	Std. Programming resolution	High resolution option	Monitor	Analyzer	Timing Output	Digital IO	Synchronized Output	RS232	LAN
DP711	1	30V/5A	150W	<500 $\mu$ Vrms	10mV	○			○		○	●	
DP712	1	50V/3A	150W	<500 $\mu$ Vrms	10mV	○			○		○	●	
DP811	1	20V/10A or 40V/5A	200W	<350 $\mu$ Vrms	10mV	○	○	○	●	○		○	○
DP821	2	8V/10A    60V/1A	140W	<350 $\mu$ Vrms	10mV/10mV	○	○	○	●	○		○	○
DP832	3	30V/3A    30V/3A, 5V/3A	195W	<350 $\mu$ Vrms	10mV/10mV/10mV	○	○	○	●	○		○	○
DP831	3	8V/5A    30V/2A, -30V/2A	160W	<350 $\mu$ Vrms	1mV/10mV/10mV	○	○	○	●	○		○	○
DP811A	1	20V/10A or 40V/5A	200W	<350 $\mu$ Vrms	1mV	●	●	●	●	●		●	●
DP821A	2	8V/10A    60V/1A	140W	<350 $\mu$ Vrms	1mV/1mV	●	●	●	●	●		●	●
DP832A	3	30V/3A    30V/3A, 5V/3A	195W	<350 $\mu$ Vrms	1mV/1mV/1mV	●	●	●	●	●		●	●
DP831A	3	8V/5A    30V/2A, -30V/2A	160W	<350 $\mu$ Vrms	1mV/1mV/1mV	●	●	●	●	●		●	●

● Standard ○ Optional

# DP800 Series Programmable Linear DC Power Supplies



DP800 Series is the high-performance programmable linear DC power supply. All models have excellent features including standard timing outputs, extremely low ripple and noise, comprehensive over-voltage, over current, over-temperature protection, a large and clear user interface, super performance and specifications. DP800A models provide standard high resolution mode (1mV/1mA), fully remote control interfaces, online monitoring and analysis functions; those functions are the options for DP800 models.

- 1, 2 or 3 outputs, the maximum power is up to 195W
- Low Ripple and Noise: <math><350\mu\text{Vrms}/2\text{mVpp}</math>
- Fast Transient Response Time: <math><50\mu\text{s}</math>
- 0.01% Linear Regulation Rate and Load Regulation Rate
- Standard Timing output; Built-in V,A,W measurements and waveform display
- 3.5 inch TFT display, easy for operation

## Intuitive User Interface

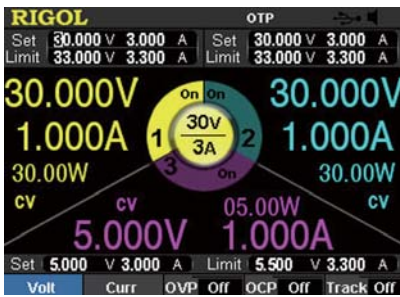

## Output On/Off Delay

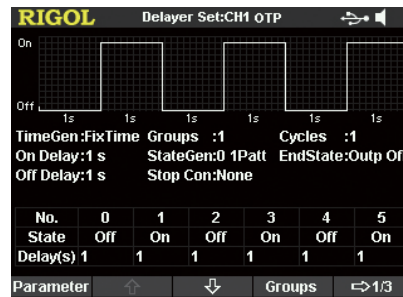

## Output Analysis

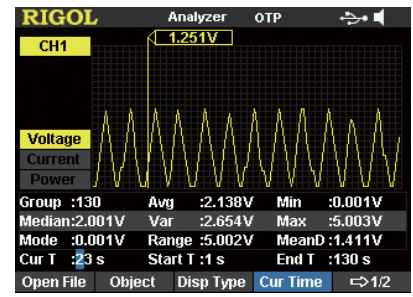

## Timing Output Setting

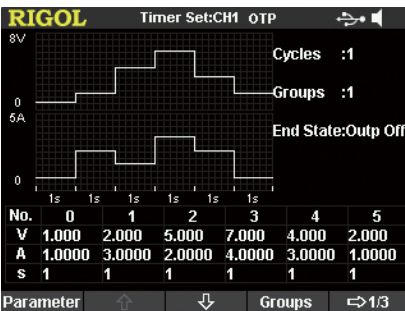

## V/A/W Waveform Display

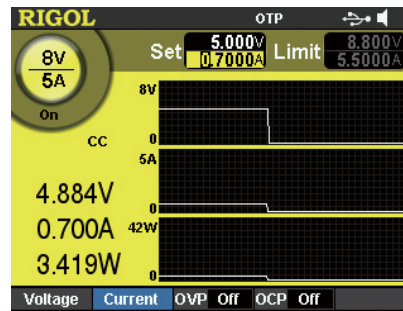

## LAN Setting

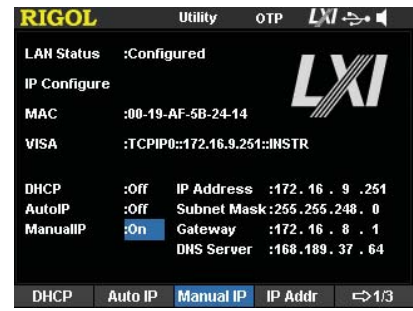

## Key Specifications

Model	DP832A	DP832	DP831A	DP831	DP821A	DP821	DP811A	DP811
Channels	3			2		1		
DC Output	30V/3A    30V/3A, 5V/3A		8V/5A    30V/2A, -30V/2A		8V/10A  60V/1A		20V/10A or 40V/5A	
Load Regulation Rate	Voltage: <math><0.01\% + 2\text{mV}</math>; Current: <math><0.01\% + 250\mu\text{A}</math>							
Linear Regulation Rate	Voltage: <math><0.01\% + 2\text{mV}</math>; Current: <math><0.01\% + 250\mu\text{A}</math>							
Ripples and Noise(20Hz-20MHz)	Normal Mode Voltage: <math><350\mu\text{Vrms}/3\text{mVpp}</math>; Normal Mode Current: <math><2\text{mArms}</math>							

Programming Annual Accuracy	Voltage	CH1	0.05% + 20mV	0.1%+5mV	0.1%+25mV	0.05%+10mV			
		CH2	0.05% + 20mV	0.05%+20mV	0.05%+10mV	-			
		CH3	0.1% + 5mV	0.05%+20mV	-	-			
	Current	CH1	0.2% + 5mA	0.2%+10mA	0.2%+10mA	0.1%+10mA			
		CH2	0.2% + 5mA	0.2%+5mA	0.2%+10mA	-			
		CH3	0.2% + 5mA	0.2%+5mA	-	-			
Readback Annual Accuracy	Voltage	CH1	0.05% + 20mV	0.1%+5mV	0.1%+25mV	0.05%+10mV			
		CH2	0.05% + 20mV	0.05%+20mV	0.05%+10mV	-			
		CH3	0.1% + 5mV	0.05%+20mV	-	-			
	Current	CH1	0.15% + 5mA	0.2%+10mA	0.15%+10mA	0.1%+10mA			
		CH2	0.15% + 5mA	0.1%+5mA	0.15%+10mA	-			
Programming Resolution	Voltage	1mV	10mV	1mV 1mV 1mV	1mV 10mV 10mV	10mV 1mV 10mV	10mV 10mV	1mV	10mV
	Current	1mA	1mA	0.3mA 0,1mA 0,1mA	1mA 1mA 1mA	0.1mA 1mA	1mA 10mA	0.5mA	10mA
Readback Resolution	Voltage	0.1mV	10mV	0.1mV	1mV	1mV 1mV	10mV 10mV	0.1mV	1mV
	Current	0.1mA	1mA	0.1mA	1mA	0.1mA 1mA	1mA 10mA	0.1mA	1mA
Display Resolution	Voltage	1mV	10mV	1mV	10mV	1mV 1mV	10mV 10mV	1mV	10mV
	Current	1mA	10mA	1mA	10mA	0.1mA 1mA	1mA 10mA	1mA	10mA
Interface	USB Device	●	●	●	●	●	●	●	●
	USB Host	●	●	●	●	●	●	●	●
	LAN	●	○	●	○	●	○	●	○
	RS232	●	○	●	○	●	○	●	○
	Digital IO	●	○	●	○	●	○	●	○
	USB-GPIB	○	○	○	○	○	○	○	○

## Ordering Information

	Description	Order Number
Models	Three channel, high resolution, Programmable Linear DC Power Supply	DP832A
	Three channel, Programmable Linear DC Power Supply	DP832
	Three channel, two polarity ,high resolution, Programmable Linear DC Power Supply	DP831A
	Three channel, two polarity ,Programmable Linear DC Power Supply	DP831
	Two channel, high resolution, Programmable Linear DC Power Supply	DP821A
	Two channel, Programmable Linear DC Power Supply	DP821
	One channel, dual ranges, high resolution, Programmable Linear DC Power Supply	DP811A
	One channel, dual ranges, Programmable Linear DC Power Supply	DP811
Standard Accessories	USB cable	CB-USBA-USBB-FF-150
	One fuse (50T-025H 250V 2.5A)	-
	One shorted device	-
	Power cord	-
Optional Accessories	1mV & 1mA High resolution option(DP8xx models)	HIRES-DP800
	4 Lines Trigger In&Out (DP8xx models)	DIGITALIO-DP800
	On-line Monitoring and analysis (DP8xx models)	AFK-DP800
	RS232 and LAN interface (DP8xx models)	INTERFACE-DP800
	USB-GPIB Converter	USB-GPIB
	Rack Mount Kit (one instrument)	RM-1-DP800
Rack Mount Kit (two instruments)	RM-2-DP800	

# DP700 Series Programmable Linear DC Power Supplies



DP700 series power supply is a type of affordable programmable linear DC power supply with high performance. DP700 series supports timing output and trigger function, and provides a remote control interface, the clear and simple user interface makes it easy to use for the customers.

- Two Models, Single Output, Max. Output Power up to 150 W
- Low ripple and noise: <math>< 500\mu\text{Vrms}/3\text{mVpp}</math> or 4mVpp
- 0.01% Excellent load and line regulation rate
- Support 1 mV/1 mA high resolution mode
- Complete OV,OT,OC protection function
- Synchronous output for multiple units
- Timing output
- 3.5-inch TFT-LCD; compact size, easy to use

Complete overvoltage/overcurrent protection (OVP/OCP)

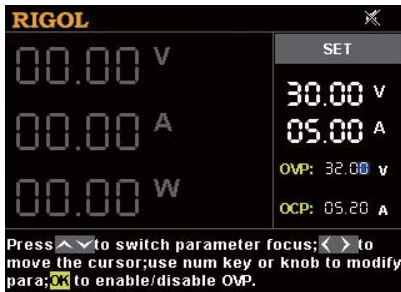

Clear and intuitive user interface, easy to use

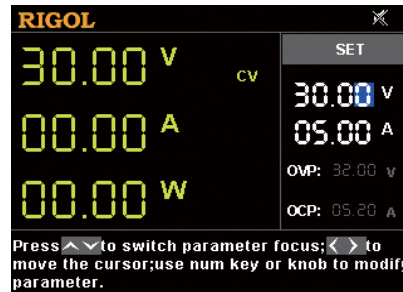

Powerful timing output function

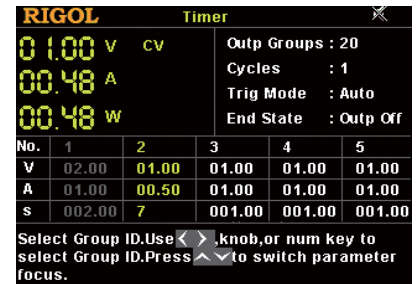

Convenient trigger function

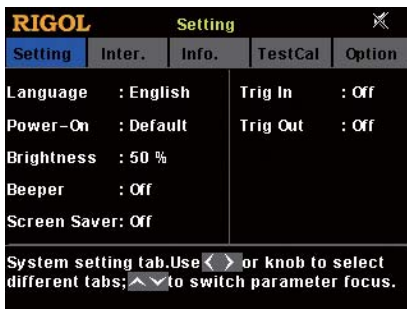

Easy-to-use function of file storage and recall

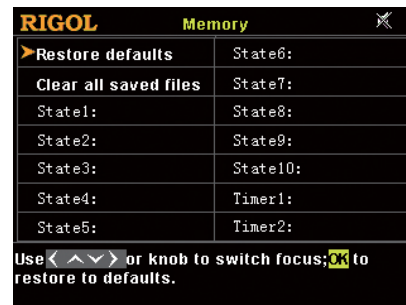

Abundant system setting function

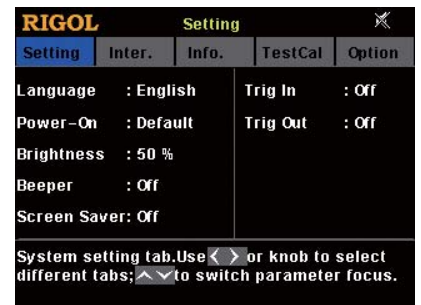

## Key Specifications

Model	Voltage/Current Rating	OVP/OCP
DP711	0 V to 30 V/0 A to 5 A	0.01 V to 33 V/0.01 A to 5.5 A
DP712	0 V to 50 V/0 A to 3 A	0.01 V to 55 V/0.01 A to 3.3 A
<b>Load Regulation, <math>\pm</math>(% of Output + Offset)</b>		
Voltage	<math>< 0.01\% + 2\text{ mV}</math>	
Current	<math>< 0.01\% + 2\text{ mA}</math>	
<b>Line Regulation, <math>\pm</math>(% of Output + Offset)</b>		
Voltage	<math>< 0.01\% + 2\text{ mV}</math>	
Current	<math>< 0.01\% + 2\text{ mA}</math>	

<b>Ripple and Noise (20 Hz to 20 MHz)</b>		
Model	Normal Mode Voltage	Normal Mode Current
DP711	<500 $\mu$ Vrms/3 mVpp	<2 mArms
DP712	<500 $\mu$ Vrms/4 mVpp	
<b>Annual Accuracy<sup>[1]</sup> (25°C <math>\pm</math> 5°C), <math>\pm</math>(% of Output + Offset)</b>		
Programming	Voltage	0.05% + 20 mV
	Current	0.2% + 10 mA
Readback	Voltage	0.05% + 20 mV
	Current	0.2% + 20 mA
<b>Resolution</b>		
Programming	Voltage	Standard: 10 mV High resolution option installed: 1 mV
	Current	Standard: 10 mA High resolution option installed: 1 mA
Readback	Voltage	Standard: 10 mV High resolution option installed: 1 mV
	Current	Standard: 10 mA High resolution option installed: 1 mA
Display	Voltage	Standard: 10 mV High resolution option installed: 1 mV
	Current	Standard: 10 mA High resolution option installed: 1 mA
<b>Transient Response Time</b>		
Less than 50 $\mu$ s for output voltage to recover to within 15 mV following a change in output current from full load to half load (or from half load to full load).		
<b>Mechanical</b>		
Dimensions	140 mm (W) x 202mm (H) x 332 mm (D)	
Weight	Net weight: 6.9 kg	
<b>Interface</b>		
RS232	1	

## Ordering Information

	Description	Order No.
Models	Programmable Linear DC Power Supply (single channel, 30V/5A)	DP711
	Programmable Linear DC Power Supply (single channel, 50V/3A)	DP712
Standard Accessories	Power Cord Conforming to the Standard of the Destination Country	-
	Either one of the following specified fuses: Fuse 50T-050H 250V 5A (AC Selector: 100 Vac or 120 Vac) Fuse 50T-025H 250V 2.5A (AC Selector: 220 Vac or 240 Vac)	-
Optional Accessories	High Resolution	HIRES-DP700
	Trigger (external synchronous trigger input and output)	TRIGGER-DP700
	Timer	TIMER-DP700
	9-Pin RS232 Cable (female-to-female, straight)	CB-DB9-DB9-F-F-150
	DP700 Series Rack Mount Kit (for a single instrument)	RM-1-DP700
	DP700 Series Rack Mount Kit (for two instruments)	RM-2-DP700
DP700 Series Rack Mount Kit (for three instruments)	RM-3-DP700	

# Programmable DC Electronic Loads



DL3000 is a cost-effective programmable DC electronic load with high performance. With a user-friendly interface and superb performance specifications, DL3000 series provides various interfaces for remote communication to meet your diversified test requirements. It can be widely used in various industries.

- 150V/40A,200W;150V/60A,350W
- Dynamic mode: up to 30 kHz
- Adjustable current slew rate: 0.001 A/μs to 5 A/μs
- Min. readback resolution: 0.1 mV, 0.1 mA
- USB-GPIB interface converter (optional)

30 kHz dynamic mode

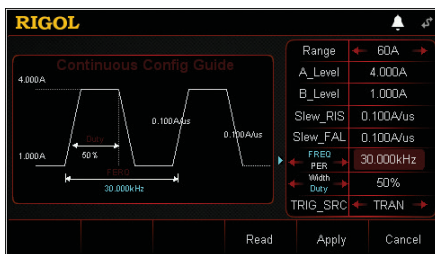

5 A/μs current slew rate

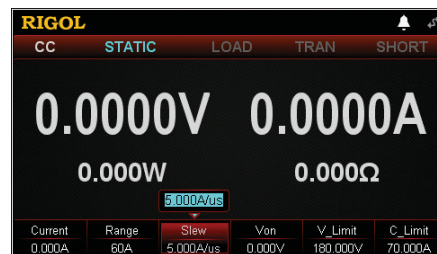

Powerful waveform display function

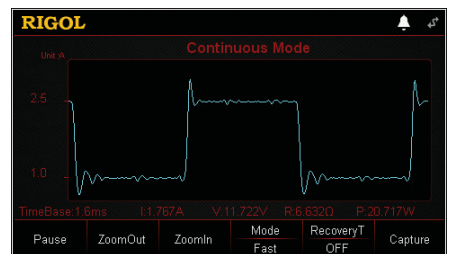

## Key Specifications

Func and Spec	DL3021		DL3021A		DL3031		DL3031A	
	Low Range	High Range	Low Range	High Range	Low Range	High Range	Low Range	High Range
Power	200W				350W			
Voltage	0~150V							
Current	0~40A				0~60A			
Type Min. Operation, Voltage(DC)	40A@1V				60A@1.3V			
<b>CC Mode</b>								
Range	0~4A	0~40A	0~4A	0~40A	0~6A	0~60A	0~6A	0~60A
Resolution	1mA							
Accuracy	±(0.05%+0.05%FS)							
Temperature Coefficient	100ppm/°C							
<b>CV Mode</b>								
Range	0~15V	0~150V	0~15V	0~150V	0~15V	0~150V	0~15V	0~150V
Resolution	1mV	5mV	1mV	5mV	1mV	5mV	1mV	5mV
Accuracy	±(0.05%+0.02%FS)	±(0.05%+0.025%FS)	±(0.05%+0.02%FS)	±(0.05%+0.025%FS)	±(0.05%+0.02%FS)	±(0.05%+0.025%FS)	±(0.05%+0.02%FS)	±(0.05%+0.025%FS)
Temperature Coefficient	50ppm/°C							
<b>CR Mode</b>								
Range	0.08Ω ~ 15Ω	2Ω ~ 15kΩ	0.08Ω ~ 15Ω	2Ω ~ 15kΩ	0.08Ω ~ 15Ω	2Ω ~ 15kΩ	0.08Ω ~ 15Ω	2Ω ~ 15kΩ
Resolution	2mA/Vsense							
Accuracy	Vin/Rset*(0.2% )+0.2% IFS							

CP Mode								
Range	0~200W				0~350W			
Resolution	100mW							
<b>CC Continuous Mode</b>								
Freq Range	0.001Hz~15kHz	0.001Hz~30kHz			0.001Hz~15kHz		0.001Hz~30kHz	
Freq Accuracy	0.8%							
Freq Resolution	±0.5%							
Duty Cycle Range	5%~95%, 1%							
<b>Slew Rate</b>								
CC SlewRate	0.001A/ μs~0.25A/μs	0.001A/μs ~ 2.5A/μs(>5V)	0.001A/ μs~0.3A/μs	0.001A/μs ~ 3A/μs(>5V)	0.001A/ μs~0.25A/μs	0.001A/μs ~ 2.5A/μs(>5V)	0.001A/ μs~0.5A/μs	0.001A/ μs~5A/ μs(>5V)
SlewRate Resolution	0.001A/μs							
Accuracy	5% +10μs							
<b>Current ReadBack</b>								
Range	0~40A				0~60A			
Resolution	1mA	0.1mA			1mA	0.1mA		
Accuracy	±(0.05%+0.05%FS)							
Temperature Coefficient	50ppm/°C							
<b>Voltage ReadBack</b>								
Range	0~150V							
Resolution	0.1mV							
Accuracy	±(0.05%+0.02%FS)							
Temperature Coefficient	20ppm/°C							
Protection Function	Overcurrent protection (OCP), overvoltage protection (OVP), overpower protection (OPP), overtemperature protection (OTP), as well as local/remote reverse voltage (LRV/RRV) protection.							
<b>DRIFT STABILITY</b>								
Current	±(0.01%±10mA)							
Voltage	±(0.01%±10mV)							
Input Resistance	350kΩ							
<b>Interface</b>								
USB DEVICE	●	●	●	●	●	●	●	●
USB HOST	●	●	●	●	●	●	●	●
RS232	●	●	●	●	●	●	●	●
LAN	○	●	○	○	○	○	○	○
Digital I/O	○	●	○	○	○	○	○	○
GPIB	○	○	○	○	○	○	○	○

## Ordering Information

	Description	Order No.
Models	Programmable DC Electronic Load (single channel, DC 150 V/40 A 200 W 15kHz 2.5A/us)	DL3021
	Programmable DC Electronic Load (single channel, DC 150 V/40 A 200 W 30kHz 3.0A/us)	DL3021A
	Programmable DC Electronic Load (single channel, DC 150 V/60 A 350 W 15kHz 2.5A/us)	DL3031
	Programmable DC Electronic Load (single channel, DC 150 V/60 A 350 W 30kHz 5.0A/us)	DL3031A
Optional Accessories	LAN Interface	LAN-DL3
	Digital I/O Option	DIGITALIO-DL3
	High Readback Resolution	HIRES-DL3
	High Frequency Option	FREQ-DL3
	High Slew Rate Option	SLEWRATE-DL3
	Terminal Shield	DL-02
	9-Pin RS232 Cable (female-to-female, cross-over)	CB-RS232-A
	USB-GPIB interface converter	USB-GPIB
	Sense Cable	CB-SENSE
	20 A Red and Black Test Lead	CB-20A-780MM
	40 A Red and Black Test Lead	CB-40A-780MM
60 A Red and Black Test Lead	CB-60A-780MM	







# alldata

## EASTERN EUROPE

### HEADQUARTER

**RIGOL TECHNOLOGIES, INC.**  
No.8 Keling Road, New District, Suzhou,  
JiangSu, P.R. China  
Tel: +86-400620002  
Email: info@rigol.com

### EUROPE

**RIGOL TECHNOLOGIES EU GmbH**  
Lindbergh str. 4  
82178 Puchheim  
Germany  
Tel: 0049-89/89418950  
Email: info-europe@rigol.com

### NORTH AMERICA

**RIGOL TECHNOLOGIES, USA INC.**  
8140 SW Nimbus Ave.  
Beaverton, OR 97008  
Tel: 877-4-**RIGOL**-1  
Fax: 877-4-**RIGOL**-1  
Email: info@rigol.com

### JAPAN

**RIGOL TECHNOLOGIES JAPAN, LLC**  
MJ Bldg. 3F, 1-7-4 Minato, Chuou-ku,  
Tokyo, Japan 104-0043  
Tel: +81-3-6262-8932  
Fax: +81-3-6262-8933  
Email: info-japan@rigol.com

**RIGOL**® is the licensed trademark of **RIGOL TECHNOLOGIES CO., LTD.** Product information in this document subject to update without notice. For the latest information about **RIGOL**'s products, applications and services, please contact local **RIGOL** Channel Partners or access **RIGOL** official website: [www.rigol.com](http://www.rigol.com)